













# İÇİNDEKİLER

MARKA	ÜRÜN	SAYFA NO
	HİDROLİK HORTUMLAR	2 - 3
	HORTUM KORUMA KILIFLARI	4
	ÇELİK ÇEKME HİDROLİK TESİSAT BORULARI	5
	HİDROLİK HORTUM BAŞLIKLARI HİDROLİK BAĞLANTI ELEMANLARI	6 - 44
	BAKIR VE ORİNGLİ PULLAR	45
	ADAPTÖRLER	46 - 55
	BASINÇ ÖLÇÜM TEST HORTUMLARI BASINÇ ÖLÇÜM TEST REKORLARI	56 - 57
	BORU KELEPÇELERİ	58 - 61
	HİDROLİK QUICK KAPLINLER HİDROLİK HAT TİPİ VALFLER HİDROLİK ÜNİTE MALZEMELERİ	62 - 74
	HİDROLİK SİLİNDİR BOĞAZ KEPLERİ HİDROLİK SİLİNDİR PİSTON HİDROLİK SİLİNDİR ARKA KAPAK	75 - 89
	YAĞ TANKI	90
	KAPLIN, KAMPANA, FİLTRELER, GÖSTERGELER, KAPAKLAR, KELEPÇE, SARI ÜRÜNLER	91 - 103

SAE 100 R1AT / EN 853 1SN

PARÇA KODU	HORTUM ÖLÇÜSÜ	DIŞ ÇAP	ÇALIŞMA BASINCI	PATLAMA BASINCI	KIVRILMA YARI ÇAPI	BİRİM FİYATI	
P/N	DN	inch	mm	BAR	BAR	mm	Euro
1002312	06	1/4"	13	225	900	38	4,27 €
1002313	08	5/16"	14,50	215	860	50	4,82 €
1002314	10	3/8"	17,50	180	720	50	5,22 €
1002315	12	1/2"	20,1	160	640	75	6,03 €
1002316	16	5/8"	23,1	130	520	89	7,41 €
1002317	19	3/4"	27,30	105	420	109	8,37 €
1002318	25	1"	35,20	90	360	140	12,11 €
1002319	31	1"1/4	42,50	65	260	419	18,16 €
1002320	38	1"1/2	49,70	50	200	500	21,10 €
1002321	51	2"	62,90	40	160	600	28,11 €

SAE 100 R2AT / EN 853 2SN

PARÇA KODU	HORTUM ÖLÇÜSÜ	DIŞ ÇAP	ÇALIŞMA BASINCI	PATLAMA BASINCI	KIVRILMA YARI ÇAPI	BİRİM FİYATI	
P/N	DN	inch	mm	BAR	BAR	mm	Euro
1001341	05	3/16"					
1001342	06	1/4"	14,50	420	1680	100	5,22 €
1001343	08	5/16"	16,10	350	1400	114	5,78 €
1001344	10	3/8"	18,50	350	1400	127	6,22 €
1001345	12	1/2"	21,40	345	1380	178	7,14 €
1001346	16	5/8"	24,60	250	1000	200	9,10 €
1001347	19	3/4"	29,00	215	860	240	10,66 €
1001348	25	1"	36,80	175	700	300	15,52 €
1001349	31	1"1/4	46,40	140	560	419	24,19 €
1001350	38	1"1/2	53,70	100	400	500	30,22 €
1001351	51	2"	65,90	90	360	600	42,22 €

**ALFAGOMMA**



EN 856 Type 4SP  
**FLEXOR 4SP**

PARÇA KODU	HORTUM ÖLÇÜSÜ	DIŞ ÇAP	ÇALIŞMA BASINCI	PATLAMA BASINCI	KIVRILMA YARI ÇAPI	BİRİM FİYATI	
P/N	DN	inch	mm	BAR	BAR	mm	Euro
1000236	06	1/4"	17,9	450	1800	150	15,60 €
1000237	10	3/8"	20	445	1780	180	15,94 €
1000238	12	1/2"	24,6	420	1680	230	17,57 €
1000239	16	5/8"	28,2	350	1400	250	20,06 €

EN 856 Type 4SH  
**FLEXOR 4SH**

PARÇA KODU	HORTUM ÖLÇÜSÜ	DIŞ ÇAP	ÇALIŞMA BASINCI	PATLAMA BASINCI	KIVRILMA YARI ÇAPI	BİRİM FİYATI	
P/N	DN	inch	mm	BAR	BAR	mm	Euro
1000245	19	3/4"	31,7	435	1740	280	24,99 €
1000246	25	1"	38,2	380	1680	340	30,30 €
1000247	31	1"1/4	45,2	350	1400	460	43,04 €
1000248	38	1"1/2	53,5	290	1160	560	62,67 €
1000249	51	2"	68	275	1100	600	82,14 €

SAE 100 R15  
**FLEXOR R15**

PARÇA KODU	HORTUM ÖLÇÜSÜ	DIŞ ÇAP	ÇALIŞMA BASINCI	PATLAMA BASINCI	KIVRILMA YARI ÇAPI	BİRİM FİYATI	
P/N	DN	inch	mm	BAR	BAR	mm	Euro
1000232	31	1"1/4	49,80	420	1700	419	85,09 €
1000233	38	1"1/2	57,30	420	1700	508	97,65 €
1000234	51	2"	72	350	1400	635	161,47 €

**ALFAGOMMA**



**FLEXBİL SİRİAL İTHAL**

BARKOD NO	ÖLÇÜ	RENK	METRAJ	FİYATI
016R25MU	16 mm	Siyah	25 mt	3,53 €
020R25MU	20 mm	Siyah	25 mt	4,13 €
025R25MU	25 mm	Siyah	25 mt	4,88 €
032R25MU	32 mm	Siyah	25 mt	5,85 €
040R25MU	40 mm	Siyah	25 mt	11,18 €
050R25MU	50 mm	Siyah	25 mt	12,08 €
063R25MU	63 mm	Siyah	25 mt	19,65 €
075R20MU	75 mm	Siyah	20 mt	23,25 €
090R20MU	90 mm	Siyah	20 mt	31,50 €

**SAFEPLAST**



**ÇELİK ÇEKME HAT BORULARI**

Stok Kodu	Dış Çap	Et Kalınlığı	Çalışma Basıncı	Test Basıncı	Patlama Basıncı	Ağırlık	Metre Fiyatı
HDB-FK001	Ø6	1,0	392	608	1250	0,123	2,59 €
HDB-FK003	Ø8	1,0	294	456	938	0,173	2,91 €
HDB-FK008	Ø10	1,5	374	580	1193	0,314	3,92 €
HDB-FK010	Ø12	1,5	311	482	992	0,388	4,40 €
HDB-FK011	Ø12	2,0	415	643	1324	0,495	5,36 €
HDB-FK015	Ø15	1,5	249	386	794	0,499	5,30 €
HDB-FK020	Ø16	2,0	311	482	992	0,690	6,81 €
HDB-FK023	Ø18	1,5	207	321	660	0,610	5,96 €
HDB-FK026	Ø20	2,0	249	386	794	0,888	8,37 €
HDB-FK030	Ø22	2,0	226	350	721	0,986	9,14 €
HDB-FK035	Ø25	3,0	299	463	954	1,628	14,48 €
HDB-FK038	Ø28	2,5	267	414	852	1,850	17,12 €
HDB-FK040	Ø30	3,0	249	386	794	1,997	17,86 €
HDB-FK042	Ø35	3,0	213	330	679	2,367	21,02 €
HDB-FK045	Ø38	4,0	262	406	836	3,354	29,59 €
HDB-FK048	Ø42	3,0	178	276	568	2,885	26,85 €

- Çelik çekme hat borularımız BENTELER markadır.
- Boylar 6mt'dir.
- Fiyatlar Euro/Mt'dir.
- Fiyatlar 6mt boy alımı içindir.

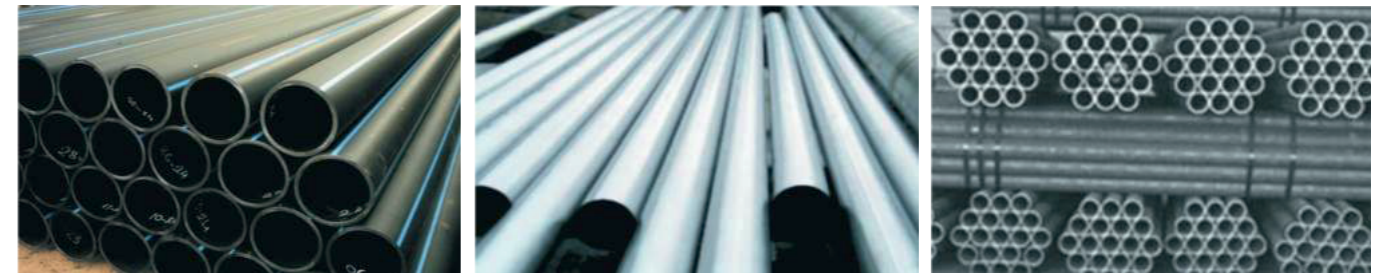





BSP İÇE HAVŞA DÜZ HORTUM REKORLARI				
Malzeme Kodu	Hortum Ölçüsü	Somun Ölçüsü	Fiyat [TL]	Kutu Adedi
RK-0613-RISD	1/4	R1/4-19	44,51	25
RK-0617-RISD	1/4	R3/8-19	58,14	25
RK-0621-RISD	1/4	R1/2-14	66,04	30
RK-0817-RISD	5/16	R3/8-19	56,47	25
RK-0821-RISD	5/16	R1/2-14	64,74	30
RK-1017-RISD	3/8	R3/8-19	53,13	50
RK-1021-RISD	3/8	R1/2-14	67,09	30
RK-1321-RISD	1/2	R1/2-14	68,02	25
RK-1626-RISD	5/8	R3/4-14	111,97	30
RK-1926-RISD	3/4	R3/4-14	106,19	25
RK-2533-RISD	1"	R1"-11	224,27	-
RK-3242-RISD	1 1/4	R1 1/4-11	365,42	-
RK-3848-RISD	1 1/2	R1 1/2-11	548,84	-

BSP İÇE HAVŞA 90° HORTUM REKORLARI				
Malzeme Kodu	Hortum Ölçüsü	Somun Ölçüsü	Fiyat [TL]	Kutu Adedi
RK-0613-RIS90	1/4	R1/4-19	77,87	25
RK-0617-RIS90	1/4	R3/8-19	91,62	20
RK-0621-RIS90	1/4	R1/2-14	137,43	25
RK-0817-RIS90	5/16	R3/8-19	96,19	30
RK-0821-RIS90	5/16	R1/2-14	137,43	25
RK-1017-RIS90	3/8	R3/8-19	96,19	25
RK-1021-RIS90	3/8	R1/2-14	137,43	20
RK-1321-RIS90	1/2	R1/2-14	137,43	15
RK-1626-RIS90	5/8	R3/4-14	242,78	15
RK-1926-RIS90	3/4	R3/4-14	242,78	10
RK-2533-RIS90	1"	R1"-11	412,26	-
RK-3242-RIS90	1 1/4	R1 1/4-11	732,90	-
RK-3848-RIS90	1 1/2	R1 1/2-11	1.190,96	-

BSP PUL SIKMALI ERKEK HORTUM REKORLARI				
Malzeme Kodu	Hortum Ölçüsü	Diş Ölçüsü	Fiyat [TL]	Kutu Adedi
RK-0510-RE	3/16	R1/8-28	33,96	50
RK-0610-RE	1/4	R1/8-28	34,53	50
RK-0613-RE	1/4	R1/4-19	40,66	30
RK-0617-RE	1/4	R3/8-19	45,32	25
RK-0621-RE	1/4	R1/2-14	74,45	30
RK-0821-RE	5/16	R1/2-14	79,17	30
RK-1017-RE	3/8	R3/8-19	46,88	50
RK-1021-RE	3/8	R1/2-14	76,79	30
RK-1321-RE	1/2	R1/2-14	82,22	30
RK-1626-RE	5/8	R3/4-14	170,17	30
RK-1633-RE	5/8	R1"-11	236,35	15
RK-1926-RE	3/4	R3/4-14	157,98	25
RK-2533-RE	1"	R1"-11	256,09	-
RK-3242-RE	1 1/4	R1 1/4-11	402,88	-
RK-3848-RE	1 1/2	R1 1/2-11	661,78	-

METRİK İÇE HAVŞA DÜZ HORTUM REKORLARI (KOMATSU)				
Malzeme Kodu	Hortum Ölçüsü	Somun Ölçüsü	Fiyat [TL]	Kutu Adedi
RK-0614-MİSD	1/4	M14x1,5	53,27	30
RK-0814-MİSD	5/16	M14x1,5	53,49	30
RK-0818-MİSD	5/16	M18x1,5	63,59	25
RK-1018-MİSD	3/8	M18x1,5	60,32	50
RK-1322-MİSD	1/2	M22x1,5	84,10	25
RK-1324-MİSD	1/2	M24x1,5	104,56	20
RK-1624-MİSD	5/8	M24x1,5	107,03	15
RK-1930-MİSD	3/4	M30x1,5	150,25	20
RK-2533-MİSD	1"	M33x1,5	273,53	10
RK-3236-MİSD	1 1/4	M36x1,5	391,23	-
RK-3242-MİSD	1 1/4	M42x1,5	472,72	-

ORFS SOMUNLU DÜZ HORTUM REKORLARI				
Malzeme Kodu	Hortum Ölçüsü	Somun Ölçüsü	Fiyat [TL]	Kutu Adedi
RK-0614-OSD	1/4	9/16-18	57,33	25
RK-0617-OSD	1/4	11/16-16	63,30	25
RK-0814-OSD	5/16	9/16-18	65,11	25
RK-0817-OSD	5/16	11/16-16	61,78	25
RK-1017-OSD	3/8	11/16-16	60,45	30
RK-1021-OSD	3/8	13/16-16	66,86	25
RK-1321-OSD	1/2	13/16-16	67,67	25
RK-1325-OSD	1/2	1"-14	94,82	20
RK-1625-OSD	5/8	1"-14	99,67	25
RK-1630-OSD	5/8	1 3/16-12	206,72	20
RK-1930-OSD	3/4	1 3/16-12	209,32	20
RK-1937-OSD	3/4	1 7/16-12	277,61	15
RK-2537-OSD	1"	1 7/16-12	324,59	-
RK-2543-OSD	1"	1 11/16-12	375,58	-
RK-3243-OSD	1 1/4	1 11/16-12	439,87	-

ORFS SOMUNLU 45° HORTUM REKORLARI				
Malzeme Kodu	Hortum Ölçüsü	Somun Ölçüsü	Fiyat [TL]	Kutu Adedi
RK-0614-OS45	1/4	9/16-18	67,21	25
RK-0617-OS45	1/4	11/16-16	70,99	25
RK-0814-OS45	5/16	9/16-18	64,06	25
RK-0817-OS45	5/16	11/16-16	69,99	25
RK-1017-OS45	3/8	11/16-16	69,00	25
RK-1021-OS45	3/8	13/16-16	82,14	25
RK-1321-OS45	1/2	13/16-16	89,60	20
RK-1325-OS45	1/2	1"-14	126,12	15
RK-1625-OS45	5/8	1"-14	130,09	20
RK-1630-OS45	5/8	1 3/16-12	238,08	15
RK-1930-OS45	3/4	1 3/16-12	245,17	15
RK-1937-OS45	3/4	1 7/16-12	345,96	10
RK-2537-OS45	1"	1 7/16-12	393,19	-
RK-2543-OS45	1"	1 11/16-12	579,35	-
RK-3243-OS45	1 1/4	1 11/16-12	663,66	-

ORFS SOMUNLU 90° HORTUM REKORLARI				
Malzeme Kodu	Hortum Ölçüsü	Somun Ölçüsü	Fiyat [TL]	Kutu Adedi
RK-0614-OS90	1/4	9/16-18	67,21	25
RK-0617-OS90	1/4	11/16-16	70,99	25
RK-0814-OS90	5/16	9/16-18	64,06	25
RK-0817-OS90	5/16	11/16-16	69,99	25
RK-1017-OS90	3/8	11/16-16	69,00	25
RK-1021-OS90	3/8	13/16-16	82,14	25
RK-1321-OS90	1/2	13/16-16	89,60	20
RK-1325-OS90	1/2	1"-14	126,12	30
RK-1625-OS90	5/8	1"-14	130,09	20
RK-1630-OS90	5/8	1 3/16-12	238,08	15
RK-1930-OS90	3/4	1 3/16-12	245,17	10
RK-1937-OS90	3/4	1 7/16-12	345,96	10
RK-2537-OS90	1"	1 7/16-12	393,19	-
RK-2543-OS90	1"	1 11/16-12	579,35	-
RK-3243-OS90	1 1/4	1 11/16-12	663,66	-

ORFS ERKEK HORTUM REKORLARI				
Malzeme Kodu	Hortum Ölçüsü	Diş Ölçüsü	Fiyat [TL]	Kutu Adedi
RK-0614-OE	1/4	9/16-18	51,07	30
RK-0617-OE	1/4	11/16-16	50,11	25
RK-0814-OE	5/16	9/16-18	47,66	30
RK-0817-OE	5/16	11/16-16	50,58	25
RK-1017-OE	3/8	11/16-16	51,27	25
RK-1021-OE	3/8	13/16-16	53,01	30
RK-1321-OE	1/2	13/16-16	53,01	30
RK-1325-OE	1/2	1"-14	69,91	20
RK-1625-OE	5/8	1"-14	83,13	20
RK-1630-OE	5/8	1 3/16-12	99,27	25
RK-1930-OE	3/4	1 3/16-12	121,15	25
RK-1937-OE	3/4	1 7/16-12	207,99	15
RK-2537-OE	1"	1 7/16-12	245,80	-
RK-2543-OE	1"	1 11/16-12	302,53	-
RK-3243-OE	1 1/4	1 11/16-12	330,89	-

BORU UÇLU DÜZ HORTUM REKORLARI				
Malzeme Kodu	Hortum Ölçüsü	Boru Ölçüsü [mm]	Fiyat [TL]	Kutu Adedi
RK-0506-BUD	3/16	6	34,01	50
RK-0606-BUD	1/4	6	34,01	50
RK-0608-BUD	1/4	8	34,01	50
RK-0610-BUD	1/4	10	34,01	50
RK-0808-BUD	5/16	8	34,01	50
RK-0810-BUD	5/16	10	34,01	50
RK-0812-BUD	5/16	12	36,85	50
RK-1008-BUD	3/8	8	36,85	40
RK-1010-BUD	3/8	10	36,85	30
RK-1012-BUD	3/8	12	36,85	30
RK-1312-BUD	1/2	12	52,32	50
RK-1316-BUD	1/2	16	52,32	40

BORU UÇLU 45° HORTUM REKORLARI				
Malzeme Kodu	Hortum Ölçüsü	Boru Ölçüsü [mm]	Fiyat [TL]	Kutu Adedi
RK-0506-BU45	3/16	6	68,01	50
RK-0606-BU45	1/4	6	68,01	30
RK-0608-BU45	1/4	8	68,01	50
RK-0610-BU45	1/4	10	68,01	40
RK-0808-BU45	5/16	8	68,01	30
RK-0810-BU45	5/16	10	68,01	30
RK-0812-BU45	5/16	12	74,08	30
RK-1008-BU45	3/8	8	74,08	30
RK-1010-BU45	3/8	10	74,08	30
RK-1012-BU45	3/8	12	74,08	25
RK-1312-BU45	1/2	12	107,93	30
RK-1316-BU45	1/2	16	107,93	20

BORU UÇLU 90° HORTUM REKORLARI				
Malzeme Kodu	Hortum Ölçüsü	Boru Ölçüsü [mm]	Fiyat [TL]	Kutu Adedi
RK-0506-BU90	3/16	6	68,01	50
RK-0606-BU90	1/4	6	68,01	50
RK-0608-BU90	1/4	8	68,01	30
RK-0610-BU90	1/4	10	68,01	30
RK-0808-BU90	5/16	8	68,01	40
RK-0810-BU90	5/16	10	68,01	30
RK-0812-BU90	5/16	12	74,08	40
RK-1008-BU90	3/8	8	74,08	30
RK-1010-BU90	3/8	10	74,08	25
RK-1012-BU90	3/8	12	74,08	30
RK-1312-BU90	1/2	12	107,93	30
RK-1316-BU90	1/2	16	107,93	20

HORTUM EKLERİ				
Malzeme Kodu	Hortum Ölçüsü	Hortum Ölçüsü	Fiyat [TL]	Kutu Adedi
RK-0505-HE	3/16	3/16	45,82	50
RK-0606-HE	1/4	1/4	41,23	50
RK-0808-HE	5/16	5/16	36,64	50
RK-1010-HE	3/8	3/8	41,23	50
RK-1313-HE	1/2	1/2	50,39	30
RK-1616-HE	5/8	5/8	91,62	30
RK-1919-HE	3/4	3/4	146,58	25
RK-2525-HE	1"	1"	229,04	-
RK-3232-HE	1"1/4	1"1/4	311,48	-
RK-3838-HE	1"1/2	1"1/2	366,46	-
RK-5050-HE	2"	2"	549,68	-

KIRICILAR İÇİN TAKVİYELİ HORTUM REKORLARI				
Malzeme Kodu	Hortum Ölçüsü	Diş Ölçüsü	Fiyat [TL]	Kutu Adedi
RK-2536-KR	1"	M36	513,02	-
RK-2542-KR	1"	M42	610,74	-
RK-2545-KR	1"	M45	622,92	-
RK-2552-KR	1"	M52	719,03	-
RK-3242-KR	1"1/4	M42	721,22	-
RK-3245-KR	1"1/4	M45	735,08	-
RK-3252-KR	1"1/4	M52	832,66	-
RK-2533-KR	1"	R1"11	547,29	-
RK-2537-KR	1"	1"7/16-12 ORFS	558,15	-
RK-3243-KR	1"1/4	1"11/16-12 ORFS	683,79	-

DN2 - DN4 SOMUNLU DÜZ RAKORLARI				
Malzeme Kodu	Hortum Ölçüsü	Diş Ölçüsü	Fiyat [TL]	Kutu Adedi
RK-0212-TSR	DN2	M12x1,5	57,91	50
RK-0214-TSR	DN2	M14x1,5	60,02	50
RK-0216-TSR	DN2	M16x1,5	63,10	50
RK-0411-TSR	DN4	7/16 UNF	58,29	50
RK-0412-TSR	DN4	M12	49,01	50
RK-0414-TSR	DN4	M14	51,36	50
RK-0416-TSR	DN4	M16	54,86	50

DN2 - DN4 SOMUNLU 90° RAKORLARI				
Malzeme Kodu	Hortum Ölçüsü	Diş Ölçüsü	Fiyat [TL]	Kutu Adedi
RK-0212-TSR90	DN2	M12x1,5	226,90	50
RK-0214-TSR90	DN2	M14x1,5	226,90	50
RK-0216-TSR90	DN2	M16x1,5	226,90	30
RK-0217-TSR90	DN2	M16x2	283,62	30
RK-0412-TSR90	DN4	M12	151,26	50
RK-0414-TSR90	DN4	M14	151,26	50
RK-0416-TSR90	DN4	M16	151,26	50

DN2 - DN4 BORU UÇLU DÜZ RAKORLARI				
Malzeme Kodu	Hortum Ölçüsü	Boru Ölçüsü [mm]	Fiyat [TL]	Kutu Adedi
RK-0206-TSB	DN2	6	51,05	-
RK-0208-TSB	DN2	8	51,05	-
RK-0210-TSB	DN2	10	51,05	-
RK-0212-TSB	DN2	12	51,05	-
RK-0406-TSB	DN4	6	41,60	50
RK-0407-TSB	DN4	6 (Vidalı)	90,76	50

DN4 BORU UÇLU 90° RAKORLARI				
Malzeme Kodu	Hortum Ölçüsü	Boru Ölçüsü [mm]	Fiyat [TL]	Kutu Adedi
RK-0406-TSB90	DN4	6	85,09	50
RK-0407-TSB90	DN4	6 (Vidalı)	124,79	50

DN2 TEST RAKORLARI				
Malzeme Kodu	Hortum Ölçüsü	Diş Ölçüsü	Fiyat [TL]	Kutu Adedi
RK-0213-TSR	DN2	R1/4	75,40	50
RK-0217-TSR	DN2	M16x2	66,12	50

**FLANŞLI DÜZ  
HORTUM REKORLARI  
3000 SERİSİ**



Malzeme Kodu	Hortum Ölçüsü	Flanş Ölçüsü	Fiyat [TL]	Kutu Adedi
RK-133007-FLD	1/2	30,2	183,41	-
RK-133807-FLD	1/2	38,1	183,41	-
RK-163807-FLD	5/8	38,1	183,41	-
RK-193807-FLD	3/4	38,1	179,63	-
RK-194408-FLD	3/4	44,4	189,08	-
RK-253807-FLD	1"	38,1	245,80	-
RK-254408-FLD	1"	44,4	226,90	-
RK-255108-FLD	1"	50,8	321,44	-
RK-324408-FLD	1 1/4	44,4	378,16	-
RK-325108-FLD	1 1/4	50,8	378,16	-
RK-326008-FLD	1 1/4	60,3	415,98	-
RK-386008-FLD	1 1/2	60,3	491,61	-
RK-507110-FLD	2"	71,4	822,50	-
RK-648410-FLD	2 1/2	84,1	1.049,39	-
RK-7610110-FLD	3"	101,6	1.219,57	-
RK-10211410-FLD	4"	114,3	1.862,44	-
RK-10212710-FLD	4"	127	2.836,20	-

**FLANŞLI 45°  
HORTUM REKORLARI  
3000 SERİSİ**



Malzeme Kodu	Hortum Ölçüsü	Flanş Ölçüsü	Fiyat [TL]	Kutu Adedi
RK-133007-FL45	1/2	30,2	205,95	-
RK-133807-FL45	1/2	38,1	248,72	-
RK-163807-FL45	5/8	38,1	257,67	-
RK-193807-FL45	3/4	38,1	264,58	-
RK-194408-FL45	3/4	44,4	290,20	-
RK-253807-FL45	1"	38,1	415,98	-
RK-254408-FL45	1"	44,4	378,16	-
RK-255108-FL45	1"	50,8	491,61	-
RK-324408-FL45	1 1/4	44,4	605,06	-
RK-325108-FL45	1 1/4	50,8	567,24	-
RK-326008-FL45	1 1/4	60,3	661,78	-
RK-386008-FL45	1 1/2	60,3	756,32	-
RK-507110-FL45	2"	71,4	1.666,27	-
RK-648410-FL45	2 1/2	84,1	2.323,32	-
RK-7610110-FL45	3"	101,6	2.642,40	-
RK-10211410-FL45	4"	114,3	4.360,66	-
RK-10212710-FL45	4"	127	4.502,47	-

**FLANŞLI 90°  
HORTUM REKORLARI  
3000 SERİSİ**

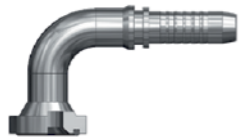

Malzeme Kodu	Hortum Ölçüsü	Flanş Ölçüsü	Fiyat [TL]	Kutu Adedi
RK-133007-FL90	1/2	30,2	205,95	-
RK-133807-FL90	1/2	38,1	248,72	-
RK-163807-FL90	5/8	38,1	257,67	-
RK-193807-FL90	3/4	38,1	264,58	-
RK-194408-FL90	3/4	44,4	290,20	-
RK-253807-FL90	1"	38,1	415,98	-
RK-254408-FL90	1"	44,4	378,16	-
RK-255108-FL90	1"	50,8	491,61	-
RK-324408-FL90	1 1/4	44,4	605,06	-
RK-325108-FL90	1 1/4	50,8	567,24	-
RK-326008-FL90	1 1/4	60,3	661,78	-
RK-386008-FL90	1 1/2	60,3	756,32	-
RK-507110-FL90	2"	71,4	1.172,30	-
RK-648410-FL90	2 1/2	84,1	2.323,32	-
RK-7610110-FL90	3"	101,6	2.642,40	-
RK-10211410-FL90	4"	114,3	4.360,66	-
RK-10212710-FL90	4"	127	4.502,47	-

**FLANŞLI DÜZ  
HORTUM REKORLARI  
6000 SERİSİ**



Malzeme Kodu	Hortum Ölçüsü	Flanş Ölçüsü	Fiyat [TL]	Kutu Adedi
RK-133208-FLD	1/2	32	183,41	-
RK-133408-FLD	1/2	34,1	183,41	-
RK-163208-FLD	5/8	32	183,41	-
RK-163408-FLD	5/8	34,1	226,90	-
RK-164110-FLD	5/8	41,3	245,80	-
RK-194110-FLD	3/4	41,3	245,80	-
RK-194810-FLD	3/4	47,6	264,71	-
RK-254110-FLD	1"	41,3	283,62	-
RK-254810-FLD	1"	47,6	283,62	-
RK-255410-FLD	1"	54	340,34	-
RK-324810-FLD	1 1/4	47,6	453,79	-
RK-325410-FLD	1 1/4	54	453,79	-
RK-326314-FLD	1 1/4	63,5	510,52	-
RK-386314-FLD	1 1/2	63,5	548,33	-

**FLANŞLI 45°  
HORTUM REKORLARI  
6000 SERİSİ**



Malzeme Kodu	Hortum Ölçüsü	Flanş Ölçüsü	Fiyat [TL]	Kutu Adedi
RK-133208-FL45	1/2	32	293,07	-
RK-133408-FL45	1/2	34,1	293,07	-
RK-163208-FL45	5/8	32	293,07	-
RK-163408-FL45	5/8	34,1	359,25	-
RK-164110-FL45	5/8	41,3	397,07	-
RK-194110-FL45	3/4	41,3	397,07	-
RK-194810-FL45	3/4	47,6	415,98	-
RK-254110-FL45	1"	41,3	453,79	-
RK-254810-FL45	1"	47,6	453,79	-
RK-255410-FL45	1"	54	548,33	-
RK-324810-FL45	1 1/4	47,6	737,41	-
RK-325410-FL45	1 1/4	54	737,41	-
RK-326314-FL45	1 1/4	63,5	816,83	-
RK-386314-FL45	1 1/2	63,5	879,22	-

**FLANŞLI 90°  
HORTUM REKORLARI  
6000 SERİSİ**



Malzeme Kodu	Hortum Ölçüsü	Flanş Ölçüsü	Fiyat [TL]	Kutu Adedi
RK-133208-FL90	1/2	32	293,07	-
RK-133408-FL90	1/2	34,1	293,07	-
RK-163208-FL90	5/8	32	293,07	-
RK-163408-FL90	5/8	34,1	359,25	-
RK-164110-FL90	5/8	41,3	397,07	-
RK-194110-FL90	3/4	41,3	397,07	-
RK-194810-FL90	3/4	47,6	415,98	-
RK-254110-FL90	1"	41,3	453,79	-
RK-254810-FL90	1"	47,6	453,79	-
RK-255410-FL90	1"	54	548,33	-
RK-324810-FL90	1 1/4	47,6	737,41	-
RK-325410-FL90	1 1/4	54	737,41	-
RK-326314-FL90	1 1/4	63,5	816,83	-
RK-386314-FL90	1 1/2	63,5	879,22	-



FLANŞLI DÜZ HORTUM REKORLARI 6000 SERİSİ (KALIN TİP)				
Malzeme Kodu	Hortum Ölçüsü	Flanş Ölçüsü	Fiyat [TL]	Kutu Adedi
RK-194110-KFLD	3/4	41,3	<b>263,84</b>	-
RK-254814-KFLD	1"	47,6	<b>307,82</b>	-
RK-255414-KFLD	1"	54	<b>329,79</b>	-
RK-324814-KFLD	1"1/4	47,6	<b>439,74</b>	-
RK-325414-KFLD	1"1/4	54	<b>439,74</b>	-
RK-326314-KFLD	1"1/4	63,5	<b>505,69</b>	-
RK-386314-KFLD	1"1/2	63,5	<b>527,68</b>	-

FLANŞLI 45° HORTUM REKORLARI 6000 SERİSİ (KALIN TİP)				
Malzeme Kodu	Hortum Ölçüsü	Flanş Ölçüsü	Fiyat [TL]	Kutu Adedi
RK-194110-KFL45	3/4	41,3	<b>422,16</b>	-
RK-254814-KFL45	1"	47,6	<b>492,50</b>	-
RK-255414-KFL45	1"	54	<b>527,68</b>	-
RK-324814-KFL45	1"1/4	47,6	<b>703,59</b>	-
RK-325414-KFL45	1"1/4	54	<b>703,59</b>	-
RK-326314-KFL45	1"1/4	63,5	<b>809,11</b>	-
RK-386314-KFL45	1"1/2	63,5	<b>879,49</b>	-

FLANŞLI 90° HORTUM REKORLARI 6000 SERİSİ (KALIN TİP)				
Malzeme Kodu	Hortum Ölçüsü	Flanş Ölçüsü	Fiyat [TL]	Kutu Adedi
RK-194110-KFL90	3/4	41,3	<b>422,16</b>	-
RK-254814-KFL90	1"	47,6	<b>492,50</b>	-
RK-255414-KFL90	1"	54	<b>527,68</b>	-
RK-324814-KFL90	1"1/4	47,6	<b>703,59</b>	-
RK-325414-KFL90	1"1/4	54	<b>703,59</b>	-
RK-326314-KFL90	1"1/4	63,5	<b>809,11</b>	-
RK-386314-KFL90	1"1/2	63,5	<b>879,49</b>	-

R1 - R2 ÇELİK SOKETLER				
Malzeme Kodu	Hortum Ölçüsü	İç Çap Ölçüsü	Fiyat [TL]	Kutu Adedi
RK-0517-ÇS	3/16	13	<b>15,78</b>	<b>100</b>
RK-0620-ÇS	1/4	14,5	<b>18,20</b>	<b>100</b>
RK-0822-ÇS	5/16	15,5	<b>21,61</b>	<b>100</b>
RK-1025-ÇS	3/8	18,4	<b>25,42</b>	<b>500</b>
RK-1328-ÇS	1/2	21,7	<b>33,07</b>	<b>300</b>
RK-1632-ÇS	5/8	24,7	<b>47,68</b>	<b>200</b>
RK-1936-ÇS	3/4	29	<b>67,67</b>	<b>150</b>
RK-2546-ÇS	1"	36,5	<b>112,00</b>	<b>70</b>
RK-3256-ÇS	1"1/4	46	<b>162,98</b>	<b>50</b>
RK-3862-ÇS	1"1/2	53	<b>221,92</b>	<b>50</b>
RK-5175-ÇS	2"	64	<b>235,32</b>	<b>40</b>
RK-6487-ÇS	2"1/2	79	<b>354,12</b>	-
RK-76103-ÇS	3"	93	<b>493,17</b>	-
RK-102132-ÇS	4"	122	<b>1.559,91</b>	-

R9 ÇELİK SOKETLER				
Malzeme Kodu	Hortum Ölçüsü	İç Çap Ölçüsü	Fiyat [TL]	Kutu Adedi
RK-1026-ÇS	3/8	18,5	<b>31,24</b>	<b>50</b>
RK-1329-ÇS	1/2	21	<b>38,57</b>	<b>50</b>
RK-1633-ÇS	5/8	25,5	<b>57,04</b>	<b>100</b>
RK-1938-ÇS	3/4	29,2	<b>68,79</b>	<b>150</b>
RK-2545-ÇS	1"	36,5	<b>126,41</b>	<b>60</b>
RK-3255-ÇS	1"1/4	44,5	<b>171,92</b>	<b>40</b>
RK-3863-ÇS	1"1/2	50	<b>220,25</b>	<b>50</b>

FLEXOPAK ÇELİK SOKETLER				
Malzeme Kodu	Hortum Ölçüsü	İç Çap Ölçüsü	Fiyat [TL]	Kutu Adedi
RK-0621-SÇS	1/4	15,7	<b>26,07</b>	<b>100</b>
RK-0824-SÇS	5/16	17,3	<b>28,29</b>	<b>100</b>
RK-1026-SÇS	3/8	19,7	<b>30,68</b>	<b>500</b>
RK-1329-SÇS	1/2	23	<b>38,79</b>	<b>300</b>
RK-1634-SÇS	5/8	26	<b>55,08</b>	<b>250</b>
RK-1938-SÇS	3/4	30,2	<b>66,02</b>	<b>150</b>
RK-2546-SÇS	1"	38,8	<b>125,07</b>	<b>80</b>

DN2 - DN4 SOKET				
Malzeme Kodu	Hortum Ölçüsü	İç Ölçüsü [mm]	Fiyat [TL]	Kutu Adedi
RK-0205-TSS	DN2	5	<b>15,53</b>	-
RK-0409-TSS	DN4	9	<b>17,31</b>	-



<b>METRİK PFX ALYANBAŞLI KÖRTAPALAR</b>				
Malzeme Kodu	Diş Ölçüsü	Alyan Ölçüsü	Fiyat [TL]	Kutu Adedi
RK-1010-MAT	M10x1	5	15,93	50
RK-1215-MAT	M12x1,5	6	20,44	50
RK-1415-MAT	M14x1,5	6	21,30	50
RK-1615-MAT	M16x1,5	8	24,64	50
RK-1815-MAT	M18x1,5	8	25,73	50
RK-2015-MAT	M20x1,5	10	29,59	30
RK-2215-MAT	M22x1,5	10	30,28	30
RK-2415-MAT	M24x1,5 (Pul Sıkmalı)	12	38,66	50
RK-2615-MAT	M26x1,5	12	52,33	25

<b>METRİK PFX KÖRTAPALAR</b>				
Malzeme Kodu	Diş Ölçüsü	Alyan Ölçüsü	Fiyat [TL]	Kutu Adedi
RK-1215-MKT	M12x1,5	17	30,97	50
RK-1415-MKT	M14x1,5	19	33,32	50
RK-1615-MKT	M16x1,5	22	38,28	50
RK-1815-MKT	M18x1,5	24	42,22	50
RK-2015-MKT	M20x1,5	27	45,59	50
RK-2215-MKT	M22x1,5	27	49,30	30
RK-2415-MKT	M24x1,5 (Pul Sıkmalı)	30	53,94	30
RK-2615-MKT	M26x1,5	32	63,34	25
RK-3020-MKT	M30x2 (Pul Sıkmalı)	36	72,23	20

<b>METRİK ERKEK TAPA</b>				
Malzeme Kodu	Diş Ölçüsü	Anahtar Ölçüsü [mm]	Fiyat [TL]	Kutu Adedi
<b>L TİPİ</b>				
RK-1006-MET-LL	M10x1 6LL	11	25,79	50
RK-1208-MET-LL	M12x1 8LL	12	26,11	50
RK-1206-MET-L	M12x1,5 6L	12	26,16	50
RK-1408-MET-L	M14x1,5 8L	14	26,85	50
RK-1610-MET-L	M16x1,5 10L	17	28,11	50
RK-1812-MET-L	M18x1,5 12L	19	29,22	50
RK-2215-MET-L	M22x1,5 15L	24	36,13	30
RK-2618-MET-L	M26x1,5 18L	27	48,13	25
RK-3022-MET-L	M30x2 22L	32	63,07	20
RK-3628-MET-L	M36x2 28L	41	102,65	15
RK-4535-MET-L	M45x2 35L	46	132,63	15
RK-5242-MET-L	M52x2 42L	55	171,78	10
<b>S TİPİ</b>				
RK-1406-MET-S	M14x1,5 6S	14	31,01	50
RK-1608-MET-S	M16x1,5 8S	17	32,63	50
RK-1810-MET-S	M18x1,5 10S	19	33,70	30
RK-2012-MET-S	M20x1,5 12S	22	36,15	30
RK-2416-MET-S	M24x1,5 16S	27	50,47	30
RK-3020-MET-S	M30x2 20S	32	67,67	25
RK-3625-MET-S	M36x2 25S	41	113,46	15
RK-4230-MET-S	M42x2 30S	46	144,87	20
RK-5238-MET-S	M52x2 38S	55	195,12	10

<b>METRİK SOMUNLU TAPA</b>				
Malzeme Kodu	Diş Ölçüsü	Anahtar Ölçüsü [mm]	Fiyat [TL]	Kutu Adedi
<b>L TİPİ</b>				
RK-1006-MST-LL	M10x1 6LL	12	34,42	50
RK-1208-MST-LL	M12x1 8LL	14	34,42	50
RK-1206-MST-L	M12x1,5 6L	14	34,41	50
RK-1408-MST-L	M14x1,5 8L	17	35,21	50
RK-1610-MST-L	M16x1,5 10L	19	38,72	50
RK-1812-MST-L	M18x1,5 12L	22	35,29	50
RK-2215-MST-L	M22x1,5 15L	27	51,76	25
RK-2618-MST-L	M26x1,5 18L	32	68,96	30
RK-3022-MST-L	M30x2 22L	36	91,12	25
RK-3628-MST-L	M36x2 28L	41	121,95	30
RK-4535-MST-L	M45x2 35L	50	181,17	30
RK-5242-MST-L	M52x2 42L	60	328,98	15
<b>S TİPİ</b>				
RK-1406-MST-S	M14x1,5 6S	17	37,24	50
RK-1608-MST-S	M16x1,5 8S	19	45,51	50
RK-1810-MST-S	M18x1,5 10S	22	49,03	30
RK-2012-MST-S	M20x1,5 12S	24	44,34	30
RK-2416-MST-S	M24x1,5 16S	30	56,92	30
RK-3020-MST-S	M30x2 20S	36	87,00	25
RK-3625-MST-S	M36x2 25S	46	139,61	30
RK-4230-MST-S	M42x2 30S	50	255,22	30
RK-5238-MST-S	M52x2 38S	60	356,03	10

<b>UNF ERKEK TAPA</b>				
Malzeme Kodu	Diş Ölçüsü	Anahtar Ölçüsü [mm]	Fiyat [TL]	Kutu Adedi
RK-1120-WET	7/16-20	12	21,04	50
RK-1220-WET	1/2-20	14	22,75	50
RK-1418-WET	9/16-18	17	24,31	50
RK-1618-WET	5/8-18	17	26,58	50
RK-1916-WET	3/4-16	19	28,95	50
RK-2214-WET	7/8-14	24	36,06	30
RK-2712-WET	1"1/16-12	27	44,76	25
RK-3312-WET	1"5/16-12	36	87,55	15
RK-4112-WET	1"5/8-12	46	148,96	15
RK-4712-WET	1"7/8-12	50	223,59	10

<b>UNF KÖR SOMUN</b>				
Malzeme Kodu	Diş Ölçüsü	Anahtar Ölçüsü [mm]	Fiyat [TL]	Kutu Adedi
RK-1120-WST	7/16-20	14	24,96	50
RK-1220-WST	1/2-20	17	26,22	50
RK-1418-WST	9/16-18	19	27,10	50
RK-1618-WST	5/8-18	21	29,50	30
RK-1916-WST	3/4-16	22	33,32	25
RK-2214-WST	7/8-14	27	44,32	30
RK-2712-WST	1"1/16-12	32	55,26	25
RK-3312-WST	1"5/16-12	41	88,07	25
RK-4112-WST	1"5/8-12	50	142,76	15
RK-4712-WST	1"7/8-12	60	208,73	10

<b>ORFS ERKEK TAPA</b>				
Malzeme Kodu	Diş Ölçüsü	Anahtar Ölçüsü [mm]	Fiyat [TL]	Kutu Adedi
RK-1418-OET	9/16-18	17	31,42	30
RK-1716-OET	11/16-16	19	32,77	30
RK-2116-OET	13/16-16	22	37,10	30
RK-2514-OET	1"-14	27	50,00	20
RK-3012-OET	1"3/16-12	32	65,38	20
RK-3712-OET	1"7/16-12	41	96,44	10
RK-4312-OET	1"11/16-12	46	151,54	10

<b>ORFS SOMUNLU TAPA</b>				
Malzeme Kodu	Diş Ölçüsü	Anahtar Ölçüsü [mm]	Fiyat [TL]	Kutu Adedi
RK-1418-OST	9/16-18	19	51,10	30
RK-1716-OST	11/16-16	22	53,13	30
RK-2116-OST	13/16-16	24	58,07	30
RK-2514-OST	1"-14	30	82,51	20
RK-3012-OST	1"3/16-12	36	109,76	20
RK-3712-OST	1"7/16-12	41	176,42	10
RK-4312-OST	1"11/16-12	50	300,88	10

UNF KAYNAKLIK NİPELLER				
Malzeme Kodu	Diş Ölçüsü	Boy Ölçüsü [mm]	Fiyat [TL]	Kutu Adedi
RK-1220-WKN	1/2-20	28,5	23,83	50
RK-1418-WKN	9/16-18	33	23,83	50
RK-1618-WKN	5/8-18	35	29,55	50
RK-1916-WKN	3/4-16	40	33,34	50
RK-2214-WKN	7/8-14	40	42,87	30
RK-2712-WKN	1"1/16-12	50	76,24	30
RK-3312-WKN	1"5/16-12	55	95,28	20

METRİK KAYNAKLIK NİPELLER				
Malzeme Kodu	Diş Ölçüsü	Fiyat [TL]	Kutu Adedi	
L TIPI				
RK-1206-MKN-L	M12x1,5 6L	25,22	50	
RK-1408-MKN-L	M14x1,5 8L	25,22	50	
RK-1610-MKN-L	M16x1,5 10L	25,22	50	
RK-1812-MKN-L	M18x1,5 12L	27,48	50	
RK-2215-MKN-L	M22x1,5 15L	32,05	50	
RK-2618-MKN-L	M26x1,5 18L	41,23	30	
RK-3022-MKN-L	M30x2 22L	68,71	30	
RK-3628-MKN-L	M36x2 28L	91,62	25	
RK-4535-MKN-L	M45x2 35L	137,43	15	
RK-5242-MKN-L	M52x2 42L	183,22	10	
S TIPI				
RK-2012-MKN-S	M20x1,5 12S	29,79	50	
RK-2416-MKN-S	M24x1,5 16S	36,64	50	
RK-3020-MKN-S	M30x2 20S	54,96	30	
RK-3625-MKN-S	M36x2 25S	91,62	20	
RK-4230-MKN-S	M42x2 30S	137,43	15	
RK-5238-MKN-S	M52x2 38S	183,22	10	

BSP ERKEK KAYNAKLIK NİPELLER				
Malzeme Kodu	Diş Ölçüsü	Boy Ölçüsü [mm]	Fiyat [TL]	Kutu Adedi
RK-1028-REK	R1/8-28	23	28,58	100
RK-1319-REK	R1/4-19	25	28,58	50
RK-1719-REK	R3/8-19	27	33,34	50
RK-2114-REK	R1/2-14	30	42,87	50
RK-2614-REK	R3/4-14	32	66,70	25
RK-3311-REK	R1"-11	35	85,75	25
RK-4211-REK	R1"1/4-11	40	109,56	15
RK-4811-REK	R1"1/2-11	44	142,92	15
RK-6011-REK	R2"-11	45	166,73	10
RK-7511-REK	R2"1/2-11	45	238,21	8
RK-8811-REK	R3"-11	45	333,48	4

BSP KAYNAKLIK MAŞONLAR				
Malzeme Kodu	Diş Ölçüsü	Boy Ölçüsü [mm]	Fiyat [TL]	Kutu Adedi
RK-1028-RKM	R1/8-28	14	26,00	50
RK-1319-RKM	R1/4-19	14	26,81	50
RK-1719-RKM	R3/8-19	14	28,06	50
RK-2114-RKM	R1/2-14	17	31,52	50
RK-2614-RKM	R3/4-14	20	42,53	50
RK-3311-RKM	R1"-11	23	54,30	25
RK-4211-RKM	R1"1/4-11	25	65,10	20
RK-4811-RKM	R1"1/2-11	27	81,44	15
RK-6011-RKM	R2"-11	28	112,29	10

METRİK KAYNAKLIK DİRSEKLER				
Malzeme Kodu	Diş Ölçüsü	Fiyat [TL]	Kutu Adedi	
L TIPI				
RK-1206-MKD-L	M12x1,5 6L	87,38	50	
RK-1408-MKD-L	M14x1,5 8L	89,02	50	
RK-1610-MKD-L	M16x1,5 10L	92,74	50	
RK-1812-MKD-L	M18x1,5 12L	94,62	50	
RK-2215-MKD-L	M22x1,5 15L	121,46	30	
RK-2618-MKD-L	M26x1,5 18L	153,09	25	
RK-3022-MKD-L	M30x2 22L	228,06	25	
RK-3628-MKD-L	M36x2 28L	311,00	15	
RK-4535-MKD-L	M45x2 35L	411,58	10	
RK-5242-MKD-L	M52x2 42L	588,05	5	
S TIPI				
RK-2012-MKD-S	M20x1,5 12S	113,40	30	
RK-2416-MKD-S	M24x1,5 16S	121,28	30	
RK-3020-MKD-S	M30x2 20S	228,06	20	
RK-3625-MKD-S	M36x2 25S	273,18	15	
RK-4230-MKD-S	M42x2 30S	407,09	10	
RK-5238-MKD-S	M52x2 38S	588,05	5	

METRİK KAYNAKLIK PERDE GEÇİŞ NİPELLERİ				
Malzeme Kodu	Diş Ölçüsü	Fiyat [TL]	Kutu Adedi	
L TIPI				
RK-0606-MKPGN-L	M12x1,5 6L	80,99	20	
RK-0808-MKPGN-L	M14x1,5 8L	80,99	20	
RK-1010-MKPGN-L	M16x1,5 10L	80,99	20	
RK-1212-MKPGN-L	M18x1,5 12L	80,99	20	
RK-1515-MKPGN-L	M22x1,5 15L	119,10	20	
RK-1818-MKPGN-L	M26x1,5 18L	142,92	20	
RK-2222-MKPGN-L	M30x2 22L	166,73	10	
RK-2828-MKPGN-L	M36x2 28L	285,84	10	
RK-3535-MKPGN-L	M45x2 35L	285,84	8	
RK-4242-MKPGN-L	M52x2 42L	381,11	5	
S TIPI				
RK-0606-MKPGN-S	M14x1,5 6S	90,51	20	
RK-0808-MKPGN-S	M16x1,5 8S	90,51	20	
RK-1010-MKPGN-S	M18x1,5 10S	90,51	20	
RK-1212-MKPGN-S	M20x1,5 12S	90,51	20	
RK-1616-MKPGN-S	M24x1,5 16S	119,10	10	
RK-2020-MKPGN-S	M30x2 20S	166,73	10	
RK-2525-MKPGN-S	M36x2 25S	190,55	8	
RK-3030-MKPGN-S	M42x2 30S	285,84	8	
RK-3838-MKPGN-S	M52x2 38S	381,11	5	

METRİK KAYNAKLIK KUYRUKLU YÜKSÜK				
Malzeme Kodu	Diş Ölçüsü	Fiyat [TL]	Kutu Adedi	
RK-0606-MKY	6 mm KUYRUKLU	34,36	50	
RK-0808-MKY	8 mm KUYRUKLU	34,36	50	
RK-1010-MKY	10 mm KUYRUKLU	36,64	50	
RK-1212-MKY	12 mm KUYRUKLU	36,64	50	
RK-1515-MKY	15 mm KUYRUKLU	54,96	25	
RK-1616-MKY	16 mm KUYRUKLU	59,55	25	
RK-1818-MKY	18 mm KUYRUKLU	68,71	25	
RK-2020-MKY	20 mm KUYRUKLU	73,30	25	
RK-2222-MKY	22 mm KUYRUKLU	82,44	25	
RK-2525-MKY	25 mm KUYRUKLU	105,35	25	
RK-2828-MKY	28 mm KUYRUKLU	114,52	25	
RK-3030-MKY	30 mm KUYRUKLU	128,26	10	
RK-3535-MKY	35 mm KUYRUKLU	137,43	10	
RK-3838-MKY	38 mm KUYRUKLU	206,13	10	
RK-4242-MKY	42 mm KUYRUKLU	206,13	10	

<b>BSP PERFLEXLİ UZUN TİP REDÜKSİYONLAR</b>				
Malzeme Kodu	Diş Ölçüsü Erkek	Diş Ölçüsü Dişi	Fiyat [TL]	Kutu Adedi
RK-1010-URD	R1/8-28	R1/8-28	33,64	50
RK-1013-URD	R1/8-28	R1/4-19	33,64	30
RK-1310-URD	R1/4-19	R1/8-28	33,64	30
RK-1313-URD	R1/4-19	R1/4-19	33,64	25
RK-1317-URD	R1/4-19	R3/8-19	41,76	30
RK-1321-URD	R1/4-19	R1/2-14	75,40	25
RK-1713-URD	R3/8-19	R1/4-19	41,76	25
RK-1717-URD	R3/8-19	R3/8-19	41,76	25
RK-1721-URD	R3/8-19	R1/2-14	95,12	30
RK-1726-URD	R3/8-19	R3/4-14	113,68	25
RK-2117-URD	R1/2-14	R3/8-19	56,84	25
RK-2121-URD	R1/2-14	R1/2-14	56,84	25
RK-2126-URD	R1/2-14	R3/4-14	121,80	25
RK-2133-URD	R1/2-14	R1"-11	150,80	20
RK-2621-URD	R3/4-14	R1/2-14	107,88	20
RK-2626-URD	R3/4-14	R3/4-14	121,80	25
RK-2633-URD	R3/4-14	R1"-11	150,80	15
RK-2642-URD	R3/4-14	R1"1/4-11	243,60	10
RK-3326-URD	R1"-11	R3/4-14	150,80	20
RK-3333-URD	R1"-11	R1"-11	150,80	20
RK-3342-URD	R1"-11	R1"1/4-11	243,60	10
RK-3348-URD	R1"-11	R1"1/2-11	324,80	10
RK-4233-URD	R1"1/4-11	R1"-11	208,80	15
RK-4242-URD	R1"1/4-11	R1"1/4-11	243,60	10
RK-4248-URD	R1"1/4-11	R1"1/2-11	324,80	10
RK-4842-URD	R1"1/2-11	R1"1/4-11	261,00	8
RK-4848-URD	R1"1/2-11	R1"1/2-11	348,00	6

<b>BSP PERFLEXLİ KISA TİP REDÜKSİYONLAR</b>				
Malzeme Kodu	Diş Ölçüsü Erkek	Diş Ölçüsü Dişi	Fiyat [TL]	Kutu Adedi
RK-1310-KRD	R1/4-19	R1/8-28	28,42	50
RK-1710-KRD	R3/8-19	R1/8-28	28,42	30
RK-1713-KRD	R3/8-19	R1/4-19	28,42	30
RK-2110-KRD	R1/2-14	R1/8-28	55,68	25
RK-2113-KRD	R1/2-14	R1/4-19	40,60	25
RK-2117-KRD	R1/2-14	R3/8-19	40,60	25
RK-2613-KRD	R3/4-14	R1/4-19	47,56	30
RK-2617-KRD	R3/4-14	R3/8-19	47,56	30
RK-2621-KRD	R3/4-14	R1/2-14	47,56	25
RK-3313-KRD	R1"-11	R1/4-19	112,52	30
RK-3317-KRD	R1"-11	R3/8-19	112,52	30
RK-3321-KRD	R1"-11	R1/2-14	112,52	25
RK-3326-KRD	R1"-11	R3/4-14	112,52	30
RK-4221-KRD	R1"1/4-11	R1/2-14	162,40	20
RK-4226-KRD	R1"1/4-11	R3/4-14	162,40	20
RK-4233-KRD	R1"1/4-11	R1"-11	162,40	20
RK-4821-KRD	R1"1/2-11	R1/2-14	191,40	10
RK-4826-KRD	R1"1/2-11	R3/4-14	191,40	10
RK-4833-KRD	R1"1/2-11	R1"-11	191,40	10
RK-4842-KRD	R1"1/2-11	R1"1/4-11	191,40	15
RK-6033-KRD	R2"-11	R1"-11	348,00	8
RK-6042-KRD	R2"-11	R1"1/4-11	348,00	8
RK-6048-KRD	R2"-11	R1"1/2-11	348,00	8

<b>BSP ALTIKÖŞE MAŞON</b>				
Malzeme Kodu	Diş Ölçüsü	Anahtar Ölçüsü [mm]	Fiyat [TL]	Kutu Adedi
RK-1028-RAM	R1/8-28	14	21,68	50
RK-1319-RAM	R1/4-19	17	26,10	30
RK-1719-RAM	R3/8-19	22	28,56	25
RK-2114-RAM	R1/2-14	27	43,82	25
RK-2614-RAM	R3/4-14	32	59,06	30
RK-3311-RAM	R1"-11	41	95,90	20
RK-4211-RAM	R1"1/4-11	50	152,77	15
RK-4811-RAM	R1"1/2-11	55	172,86	10
RK-6011-RAM	R2"-11	70	371,78	6

<b>BORU SOMUNLARI</b>				
Malzeme Kodu	Somun Ölçüsü	Fiyat [€]	Kutu Adedi	
<b>L TİPİ</b>				
RK-0106-BS-LL	M10x1 6LL	€ 0,27	100	
RK-0108-BS-LL	M12x1 8LL	€ 0,27	100	
RK-0106-BS-L	M12x1,5 6L	€ 0,24	100	
RK-0108-BS-L	M14x1,5 8L	€ 0,28	100	
RK-0110-BS-L	M16x1,5 10L	€ 0,34	100	
RK-0112-BS-L	M18x1,5 12L	€ 0,36	100	
RK-0115-BS-L	M22x1,5 15L	€ 0,52	100	
RK-0118-BS-L	M26x1,5 18L	€ 0,81	100	
RK-0122-BS-L	M30x2 22L	€ 1,03	50	
RK-0128-BS-L	M36x2 28L	€ 1,60	25	
RK-0135-BS-L	M45x2 35L	€ 2,01	25	
RK-0142-BS-L	M52x2 42L	€ 4,01	15	
<b>S TİPİ</b>				
RK-0206-BS-S	M14x1,5 6S	€ 0,37	-	
RK-0208-BS-S	M16x1,5 8S	€ 0,42	-	
RK-0210-BS-S	M18x1,5 10S	€ 0,46	-	
RK-0212-BS-S	M20x1,5 12S	€ 0,48	100	
RK-0214-BS-S	M22x1,5 14S	€ 0,93	-	
RK-0216-BS-S	M24x1,5 16S	€ 0,80	100	
RK-0220-BS-S	M30x2 20S	€ 1,09	50	
RK-0225-BS-S	M36x2 25S	€ 1,72	25	
RK-0230-BS-S	M42x2 30S	€ 2,01	20	
RK-0238-BS-S	M52x2 38S	€ 4,58	15	

<b>ÇELİK YÜKSÜKLER</b>			
Malzeme Kodu	Boru Çapı [mm]	Fiyat [€]	Kutu Adedi
<b>L TİPİ</b>			
RK-0106-ÇY-LL	6LL	€ 0,27	-
RK-0108-ÇY-LL	8LL	€ 0,28	-
RK-0106-ÇY	6	€ 0,22	100
RK-0108-ÇY	8	€ 0,24	100
RK-0110-ÇY	10	€ 0,34	100
RK-0112-ÇY	12	€ 0,36	100
RK-0115-ÇY	15	€ 0,50	100
RK-0118-ÇY	18	€ 0,71	50
RK-0122-ÇY	22	€ 1,03	50
RK-0128-ÇY	28	€ 1,50	50
RK-0135-ÇY	35	€ 2,66	25
RK-0142-ÇY	42	€ 3,51	25
<b>S TİPİ</b>			
RK-0216-ÇY	16	€ 0,58	100
RK-0220-ÇY	20	€ 1,00	50
RK-0225-ÇY	25	€ 1,43	50
RK-0230-ÇY	30	€ 2,02	25
RK-0238-ÇY	38	€ 3,63	25





<b>METRİK BLOK - UNF NİPELLER</b>				
Malzeme Kodu	Diş Ölçüsü METRİK	Diş Ölçüsü UNF	Fiyat [TL]	Kutu Adedi
RK-1616-MWN	M16x1,5	5/8-18	52,20	30
RK-1619-MWN	M16x1,5	3/4-16	52,20	25
RK-1819-MWN	M18x1,5	3/4-16	58,00	40
RK-2216-MWN	M22x1,5	5/8-18	95,12	30
RK-2219-MWN	M22x1,5	3/4-16	95,12	30

<b>UNF BLOK ORİNGLİ - UNF NİPELLER</b>				
Malzeme Kodu	Diş Ölçüsü UNF	Diş Ölçüsü UNF	Fiyat [TL]	Kutu Adedi
RK-1111-WWBN	7/16-20	7/16-20	42,87	50
RK-1212-WWBN	1/2-20	1/2-20	47,65	50
RK-1414-WWBN	9/16-18	9/16-18	47,65	50
RK-1919-WWBN	3/4-16	3/4-16	61,94	30
RK-2222-WWBN	7/8-14	7/8-14	76,24	30
RK-2727-WWBN	1"1/16-12	1"1/16-12	142,92	30
RK-3333-WWBN	1"5/16-12	1"5/16-12	214,38	20
RK-4141-WWBN	1"5/8-12	1"5/8-12	285,84	10

<b>UNF BLOK ORİNGLİ - METRİK NİPELLER</b>				
Malzeme Kodu	Diş Ölçüsü UNF	Diş Ölçüsü METRİK	Fiyat [TL]	Kutu Adedi
<b>L TİPİ</b>				
RK-1108-WMN-L	7/16-20	M14x1,5 8L	28,07	50
RK-1110-WMN-L	7/16-20	M16x1,5 10L	28,26	50
RK-1410-WMN-L	9/16-18	M16x1,5 10L	29,88	30
RK-1412-WMN-L	9/16-18	M18x1,5 12L	29,88	30
RK-1912-WMN-L	3/4-16	M18x1,5 12L	40,95	30
RK-1915-WMN-L	3/4-16	M22x1,5 15L	41,32	30
RK-2212-WMN-L	7/8-14	M18x1,5 12L	64,61	30
RK-2215-WMN-L	7/8-14	M22x1,5 15L	65,08	30
RK-2218-WMN-L	7/8-14	M26x1,5 18L	65,08	25
RK-2722-WMN-L	1"1/16-12	M30x2 22L	112,74	30
<b>S TİPİ</b>				
RK-1410-WMN-S	9/16-18	M18x1,5 10S	36,48	25
RK-1912-WMN-S	3/4-16	M20x1,5 12S	42,80	30
RK-1916-WMN-S	3/4-16	M24x1,5 16S	43,55	30
RK-2216-WMN-S	7/8-14	M24x1,5 16S	77,11	30
RK-2220-WMN-S	7/8-14	M30x2 20S	116,02	30
RK-2720-WMN-S	1"1/16-12	M30x2 20S	117,35	30
RK-3325-WMN-S	1"5/16-12	M36x2 25S	189,64	20
RK-4130-WMN-S	1"5/8-12	M42x2 30S	277,47	10

<b>UNF BLOK ORİNGLİ - ORFS NİPELLER</b>				
Malzeme Kodu	Diş Ölçüsü UNF	Diş Ölçüsü ORFS	Fiyat [TL]	Kutu Adedi
RK-1114-WON	7/16-20	9/16-18	57,16	30
RK-1414-WON	9/16-18	9/16-18	71,46	25
RK-1417-WON	9/16-18	11/16-16	71,46	25
RK-1917-WON	3/4-16	11/16-16	76,24	25
RK-1921-WON	3/4-16	13/16-16	76,24	25
RK-1925-WON	3/4-16	1"-14	95,28	20
RK-2221-WON	7/8-14	13/16-16	95,28	25
RK-2225-WON	7/8-14	1"-14	95,28	25
RK-2730-WON	1"1/16-12	1"3/16-12	190,55	30
RK-3330-WON	1"5/16-12	1"3/16-12	262,01	20
RK-3337-WON	1"5/16-12	1"7/16-12	285,84	20
RK-4143-WON	1"5/8-12	1"11/16-12	333,48	10

<b>BSP ARA NİPELİ</b>			
Malzeme Kodu	Diş Ölçüsü BSP	Fiyat [TL]	Kutu Adedi
RK-1010-RRN	R1/8-28	24,58	50
RK-1313-RRN	R1/4-19	32,14	50
RK-1717-RRN	R3/8-19	35,93	50
RK-2121-RRN	R1/2-14	62,40	50
RK-2323-RRN	R5/8-14	122,90	25
RK-2626-RRN	R3/4-14	88,87	30
RK-3333-RRN	R1"-11	132,36	20
RK-4242-RRN	R1"1/4-11	189,08	10
RK-4848-RRN	R1"1/2-11	217,44	8
RK-6060-RRN	R2"-11	406,52	-
RK-7575-RRN	R2"1/2-11	453,79	-
RK-8888-RRN	R3"-11	557,79	-

<b>BSP-BSP ORANTI NİPELLERİ</b>				
Malzeme Kodu	Diş Ölçüsü BSP	Diş Ölçüsü BSP	Fiyat [TL]	Kutu Adedi
RK-1013-RRON	R1/8-28	R1/4-19	34,03	50
RK-1017-RRON	R1/8-28	R3/8-19	35,93	30
RK-1317-RRON	R1/4-19	R3/8-19	35,93	30
RK-1321-RRON	R1/4-19	R1/2-14	62,40	30
RK-1326-RRON	R1/4-19	R3/4-14	75,63	50
RK-1721-RRON	R3/8-19	R1/2-14	62,40	30
RK-1726-RRON	R3/8-19	R3/4-14	75,63	20
RK-2123-RRON	R1/2-14	R5/8-14	94,54	25
RK-2126-RRON	R1/2-14	R3/4-14	75,63	50
RK-2133-RRON	R1/2-14	R1"-11	151,26	25
RK-2326-RRON	R5/8-14	R3/4-14	122,90	20
RK-2633-RRON	R3/4-14	R1"-11	156,94	20
RK-2642-RRON	R3/4-14	R1"1/4-11	226,90	10
RK-2648-RRON	R3/4-14	R1"1/2-11	274,17	10
RK-3342-RRON	R1"-11	R1"1/4-11	236,35	15
RK-3348-RRON	R1"-11	R1"1/2-11	255,26	10
RK-3360-RRON	R1"-11	R2"-11	444,34	5
RK-4248-RRON	R1"1/4-11	R1"1/2-11	255,26	8
RK-4260-RRON	R1"1/4-11	R2"-11	444,34	5
RK-4860-RRON	R1"1/2-11	R2"-11	444,34	5
RK-6075-RRON	R2"-11	R2"1/2-11	813,04	-
RK-7588-RRON	R2"1/2-11	R3"-11	907,58	-

<b>BSP - ORFS PFX NİPELLER</b>				
Malzeme Kodu	Diş Ölçüsü BSP	Diş Ölçüsü ORFS	Fiyat [TL]	Kutu Adedi
RK-1314-RON	R1/4-19	9/16-18	45,70	30
RK-1317-RON	R1/4-19	11/16-16	45,94	25
RK-1717-RON	R3/8-19	11/16-16	49,02	25
RK-1721-RON	R3/8-19	13/16-16	49,64	25
RK-2121-RON	R1/2-14	13/16-16	85,39	30
RK-2125-RON	R1/2-14	1"-14	86,80	25
RK-2630-RON	R3/4-14	1"3/16-12	126,80	30
RK-2637-RON	R3/4-14	1"7/16-12	149,65	20
RK-3337-RON	R1"-11	1"7/16-12	151,82	20
RK-3343-RON	R1"-11	1"11/16-12	263,90	15
RK-4237-RON	R1"1/4-11	1"7/16-12	299,59	10
RK-4243-RON	R1"1/4-11	1"11/16-12	337,41	10

















ORFS DİRSEKLER			
			
Malzeme Kodu	Diş Ölçüsü	Fiyat [TL]	Kutu Adedi
RK-1414-OD	9/16-18	100,13	30
RK-1717-OD	11/16-16	108,48	25
RK-2121-OD	13/16-16	119,71	30
RK-2525-OD	1"-14	181,05	20
RK-3030-OD	1"3/16-12	214,67	10
RK-3737-OD	1"7/16-12	301,31	15
RK-4343-OD	1"11/16-12	403,96	10

ORFS TERS DİRSEKLER			
			
Malzeme Kodu	Diş Ölçüsü	Fiyat [TL]	Kutu Adedi
RK-1414-OTD	9/16-18	122,09	25
RK-1717-OTD	11/16-16	130,77	25
RK-2121-OTD	13/16-16	145,50	25
RK-2525-OTD	1"-14	222,33	15
RK-3030-OTD	1"3/16-12	278,49	20
RK-3737-OTD	1"7/16-12	406,23	10
RK-4343-OTD	1"11/16-12	529,39	6

ORFS YANBACAK TE			
			
Malzeme Kodu	Diş Ölçüsü	Fiyat [TL]	Kutu Adedi
RK-1414-OYT	9/16-18	233,53	30
RK-1717-OYT	11/16-16	241,15	25
RK-2121-OYT	13/16-16	264,68	20
RK-2525-OYT	1"-14	346,05	20
RK-3030-OYT	1"3/16-12	391,01	10
RK-3737-OYT	1"7/16-12	519,15	8
RK-4343-OYT	1"11/16-12	643,22	6

ORFS ORTABACAK TE			
			
Malzeme Kodu	Diş Ölçüsü	Fiyat [TL]	Kutu Adedi
RK-1414-OOT	9/16-18	233,53	30
RK-1717-OOT	11/16-16	241,15	25
RK-2121-OOT	13/16-16	264,68	20
RK-2525-OOT	1"-14	346,05	20
RK-3030-OOT	1"3/16-12	391,01	10
RK-3737-OOT	1"7/16-12	519,15	10
RK-4343-OOT	1"11/16-12	643,22	5

ORFS TE			
			
Malzeme Kodu	Diş Ölçüsü	Fiyat [TL]	Kutu Adedi
RK-1414-OT	9/16-18	210,51	25
RK-1717-OT	11/16-16	219,30	30
RK-2121-OT	13/16-16	238,88	25
RK-2525-OT	1"-14	307,37	15
RK-3030-OT	1"3/16-12	330,33	15
RK-3737-OT	1"7/16-12	417,73	10
RK-4343-OT	1"11/16-12	517,78	6

UNF DİRSEKLER			
			
Malzeme Kodu	Diş Ölçüsü	Fiyat [TL]	Kutu Adedi
RK-1111-WD	7/16-20	90,68	50
RK-1212-WD	1/2-20	95,70	30
RK-1414-WD	9/16-18	99,03	25
RK-1616-WD	5/8-18	99,03	25
RK-1919-WD	3/4-16	110,26	30
RK-2222-WD	7/8-14	151,51	20
RK-2727-WD	1"1/16-12	176,85	25
RK-3333-WD	1"5/16-12	216,22	15
RK-4141-WD	1"5/8-12	403,96	6
RK-4747-WD	1"7/8-12	572,41	5

UNF TERS DİRSEKLER			
			
Malzeme Kodu	Diş Ölçüsü	Fiyat [TL]	Kutu Adedi
RK-1111-WTD	7/16-20	105,50	30
RK-1212-WTD	1/2-20	108,91	25
RK-1414-WTD	9/16-18	114,93	25
RK-1616-WTD	5/8-18	119,32	30
RK-1919-WTD	3/4-16	135,42	25
RK-2222-WTD	7/8-14	184,54	25
RK-2727-WTD	1"1/16-12	227,19	20
RK-3333-WTD	1"5/16-12	332,69	10
RK-4141-WTD	1"5/8-12	550,49	5
RK-4747-WTD	1"7/8-12	748,26	4

UNF YANBACAK TE			
			
Malzeme Kodu	Diş Ölçüsü	Fiyat [TL]	Kutu Adedi
RK-1111-WYT	7/16-20	134,34	30
RK-1212-WYT	1/2-20	136,32	30
RK-1414-WYT	9/16-18	143,07	30
RK-1616-WYT	5/8-18	144,61	25
RK-1919-WYT	3/4-16	169,51	20
RK-2222-WYT	7/8-14	214,18	20
RK-2727-WYT	1"1/16-12	264,07	15
RK-3333-WYT	1"5/16-12	436,74	8
RK-4141-WYT	1"5/8-12	664,32	5
RK-4747-WYT	1"7/8-12	916,66	3

UNF ORTABACAK TE			
			
Malzeme Kodu	Diş Ölçüsü	Fiyat [TL]	Kutu Adedi
RK-1111-WOT	7/16-20	134,34	30
RK-1212-WOT	1/2-20	136,32	30
RK-1414-WOT	9/16-18	143,07	30
RK-1616-WOT	5/8-18	144,61	25
RK-1919-WOT	3/4-16	169,51	20
RK-2222-WOT	7/8-14	214,18	20
RK-2727-WOT	1"1/16-12	264,07	15
RK-3333-WOT	1"5/16-12	436,74	8
RK-4141-WOT	1"5/8-12	664,32	5
RK-4747-WOT	1"7/8-12	916,66	3

UNF TE			
			
Malzeme Kodu	Diş Ölçüsü	Fiyat [TL]	Kutu Adedi
RK-1111-WT	7/16-20	115,97	50
RK-1212-WT	1/2-20	120,14	30
RK-1414-WT	9/16-18	124,76	30
RK-1616-WT	5/8-18	124,76	30
RK-1919-WT	3/4-16	144,34	25
RK-2222-WT	7/8-14	178,67	15
RK-2727-WT	1"1/16-12	216,89	20
RK-3333-WT	1"5/16-12	323,19	10
RK-4141-WT	1"5/8-12	517,78	6
RK-4747-WT	1"7/8-12	740,81	3

<b>BSPT - BSP DİRSEKLER</b>				
Malzeme Kodu	Diş Ölçüsü BSPT	Diş Ölçüsü BSP	Fiyat [TL]	Kutu Adedi
RK-1010-NRD	1/8-28 BSPT	R1/8-28	<b>89,60</b>	<b>50</b>
RK-1313-NRD	1/4-19 BSPT	R1/4-19	<b>97,20</b>	<b>30</b>
RK-1717-NRD	3/8-19 BSPT	R3/8-19	<b>90,96</b>	<b>25</b>
RK-2121-NRD	1/2-14 BSPT	R1/2-14	<b>112,07</b>	<b>25</b>
RK-2626-NRD	3/4-14 BSPT	R3/4-14	<b>156,23</b>	<b>25</b>
RK-3333-NRD	1"-11 BSPT	R1"-11	<b>236,86</b>	<b>15</b>
RK-4242-NRD	1 1/4-11 BSPT	R1 1/4-11	<b>325,30</b>	<b>10</b>
RK-4848-NRD	1 1/2-11 BSPT	R1 1/2-11	<b>544,05</b>	<b>5</b>

<b>BSPT - BSP TERS DİRSEKLER</b>				
Malzeme Kodu	Diş Ölçüsü BSPT	Diş Ölçüsü BSP	Fiyat [TL]	Kutu Adedi
RK-1010-RTD	1/8-28 BSPT	R1/8-28	<b>107,18</b>	<b>50</b>
RK-1313-RTD	1/4-19 BSPT	R1/4-19	<b>115,36</b>	<b>25</b>
RK-1717-RTD	3/8-19 BSPT	R3/8-19	<b>113,92</b>	<b>30</b>
RK-2121-RTD	1/2-14 BSPT	R1/2-14	<b>140,79</b>	<b>20</b>
RK-2626-RTD	3/4-14 BSPT	R3/4-14	<b>200,77</b>	<b>20</b>
RK-3333-RTD	1"-11 BSPT	R1"-11	<b>316,42</b>	<b>10</b>
RK-4242-RTD	1 1/4-11 BSPT	R1 1/4-11	<b>464,72</b>	<b>6</b>
RK-4848-RTD	1 1/2-11 BSPT	R1 1/2-11	<b>723,49</b>	<b>4</b>
RK-6060-RTD	2"-11 BSPT	R2"-11	<b>1.326,77</b>	<b>-</b>

<b>BSP YANBACAK TE</b>			
Malzeme Kodu	Diş Ölçüsü	Fiyat [TL]	Kutu Adedi
RK-1010-RYT	R1/8-28	<b>139,68</b>	<b>25</b>
RK-1313-RYT	R1/4-19	<b>145,51</b>	<b>20</b>
RK-1717-RYT	R3/8-19	<b>141,93</b>	<b>25</b>
RK-2121-RYT	R1/2-14	<b>187,10</b>	<b>15</b>
RK-2626-RYT	R3/4-14	<b>219,55</b>	<b>20</b>
RK-3333-RYT	R1"-11	<b>399,84</b>	<b>10</b>
RK-4242-RYT	R1 1/4-11	<b>619,39</b>	<b>5</b>
RK-4848-RYT	R1 1/2-11	<b>816,26</b>	<b>3</b>

<b>BSP ORTABACAK TE</b>			
Malzeme Kodu	Diş Ölçüsü	Fiyat [TL]	Kutu Adedi
RK-1010-ROT	R1/8-28	<b>139,68</b>	<b>25</b>
RK-1313-ROT	R1/4-19	<b>145,51</b>	<b>20</b>
RK-1717-ROT	R3/8-19	<b>141,93</b>	<b>25</b>
RK-2121-ROT	R1/2-14	<b>187,10</b>	<b>15</b>
RK-2626-ROT	R3/4-14	<b>219,55</b>	<b>20</b>
RK-3333-ROT	R1"-11	<b>399,84</b>	<b>10</b>
RK-4242-ROT	R1 1/4-11	<b>619,39</b>	<b>5</b>
RK-4848-ROT	R1 1/2-11	<b>816,26</b>	<b>3</b>

<b>BSP ERKEK TE</b>			
Malzeme Kodu	Diş Ölçüsü	Fiyat [TL]	Kutu Adedi
RK-1010-RTE	R1/8-28	<b>121,90</b>	<b>30</b>
RK-1313-RTE	R1/4-19	<b>125,42</b>	<b>25</b>
RK-1717-RTE	R3/8-19	<b>120,14</b>	<b>30</b>
RK-2121-RTE	R1/2-14	<b>154,08</b>	<b>15</b>
RK-2626-RTE	R3/4-14	<b>175,01</b>	<b>25</b>
RK-3333-RTE	R1"-11	<b>304,28</b>	<b>10</b>
RK-4242-RTE	R1 1/4-11	<b>470,51</b>	<b>6</b>
RK-4848-RTE	R1 1/2-11	<b>646,27</b>	<b>4</b>

<b>BSP DİŞİ TE</b>			
Malzeme Kodu	Diş Ölçüsü	Fiyat [TL]	Kutu Adedi
RK-1010-DT	R1/8-28	<b>116,00</b>	<b>20</b>
RK-1313-DT	R1/4-19	<b>119,48</b>	<b>25</b>
RK-1717-DT	R3/8-19	<b>141,52</b>	<b>20</b>
RK-2121-DT	R1/2-14	<b>191,40</b>	<b>20</b>
RK-2626-DT	R3/4-14	<b>301,60</b>	<b>10</b>
RK-3333-DT	R1"-11	<b>394,40</b>	<b>8</b>
RK-4242-DT	R1 1/4-11	<b>661,20</b>	<b>4</b>

<b>BSP DİŞİ DİRSEK</b>			
Malzeme Kodu	Diş Ölçüsü	Fiyat [TL]	Kutu Adedi
RK-1010-DD	R1/8-28	<b>94,54</b>	<b>30</b>
RK-1313-DD	R1/4-19	<b>87,00</b>	<b>30</b>
RK-1717-DD	R3/8-19	<b>94,54</b>	<b>25</b>
RK-2121-DD	R1/2-14	<b>132,24</b>	<b>25</b>
RK-2626-DD	R3/4-14	<b>174,00</b>	<b>15</b>
RK-3333-DD	R1"-11	<b>272,60</b>	<b>10</b>
RK-4242-DD	R1 1/4-11	<b>472,12</b>	<b>4</b>
RK-4848-DD	R1 1/2-11	<b>982,52</b>	<b>4</b>

<b>BSPT - BSP KUYRUKLU DİRSEK</b>				
Malzeme Kodu	Diş Ölçüsü BSPT	Diş Ölçüsü (Dişi) BSP	Fiyat [TL]	Kutu Adedi
RK-1010-KD	1/8-28 BSPT	R1/8-28	<b>105,65</b>	<b>30</b>
RK-1313-KD	1/4-19 BSPT	R1/4-19	<b>100,80</b>	<b>25</b>
RK-1717-KD	3/8-19 BSPT	R3/8-19	<b>112,74</b>	<b>25</b>
RK-2121-KD	1/2-14 BSPT	R1/2-14	<b>167,40</b>	<b>15</b>
RK-2626-KD	3/4-14 BSPT	R3/4-14	<b>244,59</b>	<b>10</b>
RK-3333-KD	1"-11 BSPT	R1"-11	<b>348,00</b>	<b>10</b>
RK-4242-KD	1 1/4-11 BSPT	R1 1/4-11	<b>515,69</b>	<b>6</b>
RK-4848-KD	1 1/2-11 BSPT	R1 1/2-11	<b>1.039,94</b>	<b>3</b>

BSP - METRİK DÖNER DİRSEKLER					
Malzeme Kodu	Diş Ölçüsü BSP	Diş Ölçüsü METRİK	Fiyat [TL]	Kutu Adedi	
<b>L TİPİ</b>					
RK-1006-RMDD-LL	R1/8-28	M10x1 6LL	174,81	30	
RK-1006-RMDD-L	R1/8-28	M12x1,5 6L	165,36	30	
RK-1008-RMDD-L	R1/8-28	M14x1,5 8L	157,79	25	
RK-1306-RMDD-L	R1/4-19	M12x1,5 6L	190,69	30	
RK-1308-RMDD-L	R1/4-19	M14x1,5 8L	190,69	30	
RK-1310-RMDD-L	R1/4-19	M16x1,5 10L	186,91	30	
RK-1312-RMDD-L	R1/4-19	M18x1,5 12L	186,91	25	
RK-1706-RMDD-L	R3/8-19	M12x1,5 6L	228,69	20	
RK-1708-RMDD-L	R3/8-19	M14x1,5 8L	213,57	20	
RK-1710-RMDD-L	R3/8-19	M16x1,5 10L	213,57	30	
RK-1712-RMDD-L	R3/8-19	M18x1,5 12L	213,57	30	
RK-1715-RMDD-L	R3/8-19	M22x1,5 15L	274,26	20	
RK-2110-RMDD-L	R1/2-14	M16x1,5 10L	278,75	20	
RK-2112-RMDD-L	R1/2-14	M18x1,5 12L	259,84	20	
RK-2115-RMDD-L	R1/2-14	M22x1,5 15L	269,29	20	
RK-2118-RMDD-L	R1/2-14	M26x1,5 18L	269,29	20	
RK-2618-RMDD-L	R3/4-14	M26x1,5 18L	367,50	10	
RK-2622-RMDD-L	R3/4-14	M30x2 22L	358,05	10	
RK-3328-RMDD-L	R1"-11	M36x2 28L	611,97	6	
RK-4235-RMDD-L	R1"1/4-11	M45x2 35L	956,21	4	
RK-4842-RMDD-L	R1"1/2-11	M52x2 42L	1.363,36	3	
<b>S TİPİ</b>					
RK-1306-RMDD-S	R1/4-19	M14x1,5 6S	203,93	25	
RK-1308-RMDD-S	R1/4-19	M16x1,5 8S	194,47	25	
RK-1710-RMDD-S	R3/8-19	M18x1,5 10S	226,80	20	
RK-1712-RMDD-S	R3/8-19	M20x1,5 12S	226,80	30	
RK-1716-RMDD-S	R3/8-19	M24x1,5 16S	271,43	20	
RK-2112-RMDD-S	R1/2-14	M20x1,5 12S	278,75	20	
RK-2116-RMDD-S	R1/2-14	M24x1,5 16S	269,29	20	
RK-2120-RMDD-S	R1/2-14	M30x2 20S	320,39	10	
RK-2616-RMDD-S	R3/4-14	M24x1,5 16S	376,95	10	
RK-2620-RMDD-S	R3/4-14	M30x2 20S	358,05	10	
RK-2625-RMDD-S	R3/4-14	M36x2 25S	508,53	10	
RK-3320-RMDD-S	R1"-11	M30x2 20S	627,10	6	
RK-3325-RMDD-S	R1"-11	M36x2 25S	627,10	6	
RK-3330-RMDD-S	R1"-11	M42x2 30S	787,80	6	
RK-4230-RMDD-S	R1"1/4-11	M42x2 30S	994,03	4	
RK-4238-RMDD-S	R1"1/4-11	M52x2 38S	1.476,44	3	
RK-4838-RMDD-S	R1"1/2-11	M52x2 38S	1.429,54	3	



BSP - METRİK OPSİYONEL TERS TE					
Malzeme Kodu	Diş BSP Ölçüsü	Erkek Diş Ölçüsü	Somun Ölçüsü	Fiyat [TL]	Kutu Adedi
RK-1316-RMTOP	R1/4-19	M24x1,5 16S	M24x1,5 16S	240,12	25
RK-1320-RMTOP	R1/4-19	M30x2 20S	M30x2 20S	327,87	15
RK-1716-RMTOP	R3/8-19	M24x1,5 16S	M24x1,5 16S	240,12	25
RK-1720-RMTOP	R3/8-19	M30x2 20S	M30x2 20S	327,87	15
RK-2125-RMTOP	R1/2-21	M36x2 25S	M36x2 25S	476,54	10

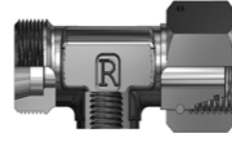

BSP - METRİK OPSİYONEL ERKEK TE					
Malzeme Kodu	Diş BSP Ölçüsü	Erkek Diş Ölçüsü	Erkek Diş Ölçüsü	Fiyat [TL]	Kutu Adedi
RK-1316-RMEOP	R1/4-19	M24x1,5 16S	M24x1,5 16S	198,51	25
RK-1320-RMEOP	R1/4-19	M30x2 20S	M30x2 20S	260,29	15
RK-1716-RMEOP	R3/8-19	M24x1,5 16S	M24x1,5 16S	198,51	25
RK-1720-RMEOP	R3/8-19	M30x2 20S	M30x2 20S	260,29	15
RK-2125-RMEOP	R1/2-21	M36x2 25S	M36x2 25S	362,11	10



**BAKIR VE ORİNGLİ PULLAR**



R" BAKIR PULLAR		
ÜRÜN KODU	ÜRÜN ADI	FİYATI
BP-18	1/8 R BAKIR PUL 1,50 MM	4,62 ₺
BP-14	1/4 R BAKIR PUL 1,50 MM	7,36 ₺
BP-38	3/8 R BAKIR PUL 1,50 MM	10,32 ₺
BP-12	1/2 R BAKIR PUL 1,50 MM	14,13 ₺
BP-34	3/4 R BAKIR PUL 1,50 MM	20,26 ₺
BP-100	1" R BAKIR PUL 1,50 MM	30,66 ₺
BP-114	1-1/4 R BAKIR PUL 1,50 MM	46,24 ₺
BP-112	1-1/2 R BAKIR PUL 1,50 MM	48,82 ₺
BP-200	2" R BAKIR PUL 1,50 MM	63,86 ₺



R" SÜPER PUL		
ÜRÜN KODU	ÜRÜN ADI	FİYATI
SP-18	1/8" SÜPER PUL	3,47 ₺
SP-14	1/4" SÜPER PUL	4,59 ₺
SP-38	3/8" SÜPER PUL	5,87 ₺
SP-12	1/2" SÜPER PUL	6,40 ₺
SP-34	3/4" SÜPER PUL	7,47 ₺
SP100	1" SÜPER PUL	12,70 ₺
SP-114	1 1/4" SÜPER PUL	16,00 ₺
SP-112	1 1/2" SÜPER PUL	23,46 ₺
SP-200	2" SÜPER PUL	26,66 ₺

**HPF-FK**

**FLANŞ KEPLERİ  
(YARIM AY)**



**FLANŞ KEPLERİ  
(YEKPARE)**

**HPF-FK**



**3000PSİ FLANŞ KEPLERİ (YARIM AY)**

KOD	ÖLÇÜ	FLANŞ ÖLÇÜSÜ	EKSEN ÖLÇÜSÜ	ÇALIŞMA BASINCI	CİVATA	FİYAT
HPF-FK-301	1/2" 3000PSİ	30,2mm	38.1x17,5	350 Bar	M8X30	<b>3,50 €</b>
HPF-FK-302	3/4" 3000PSİ	38,1mm	47,6x22,3	350 Bar	M10X35	<b>4,00 €</b>
HPF-FK-303	1" 3000PSİ	44,4mm	52,4x26,2	315 Bar	M10X35	<b>4,50 €</b>
HPF-FK-304	1 1/4" 3000PSİ	50,8mm	58,7x30,2	250 Bar	M10X40	<b>5,70 €</b>
HPF-FK-305	1 1/2" 3000PSİ	60,3mm	69,9x35,7	200 Bar	M12X45	<b>6,70 €</b>
HPF-FK-306	2" 3000PSİ	71,4mm	77,8x42,9	200 Bar	M12X45	<b>7,70 €</b>
HPF-FK-307	2 1/2" 3000PSİ	84,1mm	89x50,8	160 Bar	M12X45	<b>13,00 €</b>
HPF-FK-308	3" 3000PSİ	101,6mm	106,4x62	100 Bar	M16X50	<b>20,00 €</b>

**3000PSİ FLANŞ KEPLERİ (YEKPARE)**

KOD	ÖLÇÜ	FLANŞ ÖLÇÜSÜ	EKSEN ÖLÇÜSÜ	ÇALIŞMA BASINCI	CİVATA	FİYAT
HPF-FKY-301	1/2" 3000PSİ	30,2mm	38.1x17,5	350 Bar	M8X30	<b>3,50 €</b>
HPF-FKY-302	3/4" 3000PSİ	38,1mm	47,6x22,3	350 Bar	M10X35	<b>4,00 €</b>
HPF-FKY-303	1" 3000PSİ	44,4mm	52,4x26,2	315 Bar	M10X35	<b>4,50 €</b>
HPF-FKY-304	1 1/4" 3000PSİ	50,8mm	58,7x30,2	250 Bar	M10X40	<b>5,70 €</b>
HPF-FKY-305	1 1/2" 3000PSİ	60,3mm	69,9x35,7	200 Bar	M12X45	<b>6,70 €</b>
HPF-FKY-306	2" 3000PSİ	71,4mm	77,8x42,9	200 Bar	M12X45	<b>7,70 €</b>
HPF-FKY-307	2 1/2" 3000PSİ	84,1mm	89x50,8	160 Bar	M12X45	<b>13,00 €</b>
HPF-FKY-308	3" 3000PSİ	101,6mm	106,4x62	100 Bar	M16X50	<b>20,00 €</b>

**6000PSİ FLANŞ KEPLERİ (YARIM AY)**

KOD	ÖLÇÜ	FLANŞ ÖLÇÜSÜ	EKSEN ÖLÇÜSÜ	ÇALIŞMA BASINCI	CİVATA	FİYAT
HPF-FK-601	1/2" 6000PSİ	32mm	40,5x18,2	420 Bar	M8X30	<b>4,00 €</b>
HPF-FK-602	3/4" 6000PSİ	41,3mm	50,8x23,8	420 Bar	M10X35	<b>5,00 €</b>
HPF-FK-603	1" 6000PSİ	47,6mm	57,2x27,8	420 Bar	M12X45	<b>7,50 €</b>
HPF-FK-604	1 1/4" 6000PSİ	54mm	66,6x31,8	420 Bar	M14X50	<b>9,00 €</b>
HPF-FK-605	1 1/2" 6000PSİ	63,5mm	79,3x36,5	420 Bar	M16X55	<b>16,00 €</b>
HPF-FK-606	2" 6000PSİ	79,4mm	96,8x44,5	420 Bar	M20X70	<b>22,00 €</b>

**6000PSİ FLANŞ KEPLERİ (YEKPARE)**

KOD	ÖLÇÜ	FLANŞ ÖLÇÜSÜ	EKSEN ÖLÇÜSÜ	ÇALIŞMA BASINCI	CİVATA	FİYAT
HPF-FKY-601	1/2" 6000PSİ	32mm	40,5x18,2	420 Bar	M8X30	<b>4,00 €</b>
HPF-FKY-602	3/4" 6000PSİ	41,3mm	50,8x23,8	420 Bar	M10X35	<b>5,00 €</b>
HPF-FKY-603	1" 6000PSİ	47,6mm	57,2x27,8	420 Bar	M12X45	<b>7,50 €</b>
HPF-FKY-604	1 1/4" 6000PSİ	54mm	66,6x31,8	420 Bar	M14X50	<b>9,00 €</b>
HPF-FKY-605	1 1/2" 6000PSİ	63,5mm	79,3x36,5	420 Bar	M16X55	<b>16,00 €</b>
HPF-FKY-606	2" 6000PSİ	79,4mm	96,8x44,5	420 Bar	M20X70	<b>22,00 €</b>



**HPF-BDA-O**

**BSP DİŞLİ ADAPTÖR  
O-RİNGLİ**



**BSP DİŞLİ ADAPTÖR  
O-RİNGSİZ**

**HPF-BDA**



**3000PSİ BSP DİŞLİ ADAPTÖR O-RİNGLİ**

KOD	ÖLÇÜ	FLANŞ ÖLÇÜSÜ	DİŞ ÖLÇÜSÜ	EKSEN ÖLÇÜSÜ	ÇALIŞMA BASINCI	O-RİNG	CİVATA	FİYAT
HPF-BDA-O-301	1/2"	3000PSİ	30,2mm	G 1/2	38,1mm x 17,5mm	350 Bar	18,64x3,53 M8X30	<b>6,00 €</b>
HPF-BDA-O-302	3/4"	3000PSİ	38,1mm	G 3/4	47,6mm x 22,3mm	350 Bar	24,99x3,53 M10X35	<b>7,50 €</b>
HPF-BDA-O-303	1"	3000PSİ	44,4mm	G 1"	52,4mm x 26,2mm	315 Bar	32,92x3,53 M10X35	<b>8,00 €</b>
HPF-BDA-O-304	1 1/4"	3000PSİ	50,8mm	G 1 1/4	58,7mm x 30,2mm	250 Bar	37,69x3,53 M10X40	<b>10,00 €</b>
HPF-BDA-O-305	1 1/2"	3000PSİ	60,3mm	G 1 1/2	69,9mm x 35,7mm	200 Bar	47,22x3,53 M12X45	<b>12,00 €</b>
HPF-BDA-O-306	2"	3000PSİ	71,4mm	G 2"	77,8mm x 42,9mm	200 Bar	56,74x3,53 M12X45	<b>15,00 €</b>
HPF-BDA-O-307	2 1/2"	3000PSİ	84,1mm	G 2 1/2	89mm x 50,8mm	160 Bar	69,44x3,53 M12X45	<b>24,60 €</b>
HPF-BDA-O-308	3"	3000PSİ	101,6mm	G 3"	106,4mm x 62mm	100 Bar	85,32x3,53 M16X50	<b>38,00 €</b>

**3000PSİ BSP DİŞLİ ADAPTÖR O-RİNG'SİZ**

KOD	ÖLÇÜ	FLANŞ ÖLÇÜSÜ	DİŞ ÖLÇÜSÜ	EKSEN ÖLÇÜSÜ	ÇALIŞMA BASINCI	CİVATA	FİYAT
HPF-BDA-301	1/2"	3000PSİ	30,2mm	G 1/2	38,1mm x 17,5mm	350 Bar	M8X30 <b>6,00 €</b>
HPF-BDA-302	3/4"	3000PSİ	38,1mm	G 3/4	47,6mm x 22,3mm	350 Bar	M10X35 <b>7,50 €</b>
HPF-BDA-303	1"	3000PSİ	44,4mm	G 1"	52,4mm x 26,2mm	315 Bar	M10X35 <b>8,00 €</b>
HPF-BDA-304	1 1/4"	3000PSİ	50,8mm	G 1 1/4	58,7mm x 30,2mm	250 Bar	M10X40 <b>10,00 €</b>
HPF-BDA-305	1 1/2"	3000PSİ	60,3mm	G 1 1/2	69,9mm x 35,7mm	200 Bar	M12X45 <b>12,00 €</b>
HPF-BDA-306	2"	3000PSİ	71,4mm	G 2"	77,8mm x 42,9mm	200 Bar	M12X45 <b>15,00 €</b>
HPF-BDA-307	2 1/2"	3000PSİ	84,1mm	G 2 1/2	89mm x 50,8mm	160 Bar	M12X45 <b>24,60 €</b>
HPF-BDA-308	3"	3000PSİ	101,6mm	G 3"	106,4mm x 62mm	100 Bar	M16X50 <b>38,00 €</b>

**6000PSİ BSP DİŞLİ ADAPTÖR O-RİNGLİ**

KOD	ÖLÇÜ	FLANŞ ÖLÇÜSÜ	DİŞ ÖLÇÜSÜ	EKSEN ÖLÇÜSÜ	ÇALIŞMA BASINCI	O-RİNG	CİVATA	FİYAT
HPF-BDA-O-601	1/2"	6000PSİ	32mm	G 1/2	40,5mm x 18,2mm	420 Bar	18,64x3,53 M8X30	<b>7,50 €</b>
HPF-BDA-O-602	3/4"	6000PSİ	41,3mm	G 3/4	50,8mm x 23,8mm	420 Bar	24,99x3,53 M10X35	<b>8,50 €</b>
HPF-BDA-O-603	1"	6000PSİ	47,6mm	G 1"	57,2mm x 27,8mm	420 Bar	32,92x3,53 M12X45	<b>10,00 €</b>
HPF-BDA-O-604	1 1/4"	6000PSİ	54mm	G 1 1/4	66,6mm x 31,8mm	420 Bar	37,69x3,53 M14X50	<b>13,00 €</b>
HPF-BDA-O-605	1 1/2"	6000PSİ	63,5mm	G 1 1/2	79,3mm x 36,5mm	420 Bar	47,22x3,53 M16X55	<b>20,00 €</b>
HPF-BDA-O-606	2"	6000PSİ	79,4mm	G 2"	96,8mm x 44,5mm	420 Bar	56,74x3,53 M20X70	<b>30,00 €</b>

**6000PSİ BSP DİŞLİ ADAPTÖR O-RİNG'SİZ**

KOD	ÖLÇÜ	FLANŞ ÖLÇÜSÜ	DİŞ ÖLÇÜSÜ	EKSEN ÖLÇÜSÜ	ÇALIŞMA BASINCI	CİVATA	FİYAT
HPF-BDA-601	1/2"	6000PSİ	32mm	G 1/2	40,5mm x 18,2mm	420 Bar	M8X30 <b>7,50 €</b>
HPF-BDA-602	3/4"	6000PSİ	41,3mm	G 3/4	50,8mm x 23,8mm	420 Bar	M10X35 <b>8,50 €</b>
HPF-BDA-603	1"	6000PSİ	47,6mm	G 1"	57,2mm x 27,8mm	420 Bar	M12X45 <b>10,00 €</b>
HPF-BDA-604	1 1/4"	6000PSİ	54mm	G 1 1/4	66,6mm x 31,8mm	420 Bar	M14X50 <b>13,00 €</b>
HPF-BDA-605	1 1/2"	6000PSİ	63,5mm	G 1 1/2	79,3mm x 36,5mm	420 Bar	M16X55 <b>20,00 €</b>
HPF-BDA-606	2"	6000PSİ	79,4mm	G 2"	96,8mm x 44,5mm	420 Bar	M20X70 <b>30,00 €</b>

**HPF-GKA-O**

**GEÇME KAYNAKLI  
ADAPTÖR O-RİNGLİ**



**GEÇME KAYNAKLI  
ADAPTÖR O-RİNGSİZ**

**HPF-GKA**



**3000PSİ GEÇME KAYNAKLI ADAPTÖR O-RİNGLİ**

KOD	ÖLÇÜ	FLANŞ ÖLÇÜSÜ	BORU Q	EKSEN ÖLÇÜSÜ	ÇALIŞMA BASINCI	O-RİNG	CİVATA	FİYAT	
HPF-GKA-O-301	1/2"	3000PSİ	30,2mm	21,5mm	38,1mm x 17,5mm	350 Bar	18,64x3,53	M8X30	<b>6,00 €</b>
HPF-GKA-O-302	3/4"	3000PSİ	38,1mm	27,2mm	47,6mm x 22,3mm	350 Bar	24,99x3,53	M10X35	<b>7,50 €</b>
HPF-GKA-O-303	1"	3000PSİ	44,4mm	34mm	52,4mm x 26,2mm	315 Bar	32,92x3,53	M10X35	<b>8,00 €</b>
HPF-GKA-O-304	1 1/4"	3000PSİ	50,8mm	42,6mm	58,7mm x 30,2mm	250 Bar	37,69x3,53	M10X40	<b>10,00 €</b>
HPF-GKA-O-305	1 1/2"	3000PSİ	60,3mm	48,8mm	69,9mm x 35,7mm	200 Bar	47,22x3,53	M12X45	<b>12,00 €</b>
HPF-GKA-O-306	2"	3000PSİ	71,4mm	60,9mm	77,8mm x 42,9mm	200 Bar	56,74x3,53	M12X45	<b>15,00 €</b>
HPF-GKA-O-307	2 1/2"	3000PSİ	84,1mm	76,6mm	89mm x 50,8mm	160 Bar	69,44x3,53	M12X45	<b>24,60 €</b>
HPF-GKA-O-308	3"	3000PSİ	101,6mm	90,5mm	106,4mm x 62mm	100 Bar	85,32x3,53	M16X50	<b>38,00 €</b>

**3000PSİ GEÇME KAYNAKLI ADAPTÖR O-RİNG'SİZ**

KOD	ÖLÇÜ	FLANŞ ÖLÇÜSÜ	BORU Q	EKSEN ÖLÇÜSÜ	ÇALIŞMA BASINCI	CİVATA	FİYAT	
HPF-GKA-301	1/2"	3000PSİ	30,2mm	21,5mm	38,1mm x 17,5mm	350 Bar	M8X30	<b>6,00 €</b>
HPF-GKA-302	3/4"	3000PSİ	38,1mm	27,2mm	47,6mm x 22,3mm	350 Bar	M10X35	<b>7,50 €</b>
HPF-GKA-303	1"	3000PSİ	44,4mm	34mm	52,4mm x 26,2mm	315 Bar	M10X35	<b>8,00 €</b>
HPF-GKA-304	1 1/4"	3000PSİ	50,8mm	42,6mm	58,7mm x 30,2mm	250 Bar	M10X40	<b>10,00 €</b>
HPF-GKA-305	1 1/2"	3000PSİ	60,3mm	48,8mm	69,9mm x 35,7mm	200 Bar	M12X45	<b>12,00 €</b>
HPF-GKA-306	2"	3000PSİ	71,4mm	60,9mm	77,8mm x 42,9mm	200 Bar	M12X45	<b>15,00 €</b>
HPF-GKA-307	2 1/2"	3000PSİ	84,1mm	76,6mm	89mm x 50,8mm	160 Bar	M12X45	<b>24,60 €</b>
HPF-GKA-308	3"	3000PSİ	101,6mm	90,5mm	106,4mm x 62mm	100 Bar	M16X50	<b>38,00 €</b>

**6000PSİ GEÇME KAYNAKLI ADAPTÖR O-RİNGLİ**

KOD	ÖLÇÜ	FLANŞ ÖLÇÜSÜ	BORU Q	EKSEN ÖLÇÜSÜ	ÇALIŞMA BASINCI	O-RİNG	CİVATA	FİYAT	
HPF-GKA-O-601	1/2"	6000PSİ	32mm	21,5mm	40,5mm x 18,2mm	420 Bar	18,64x3,53	M8X30	<b>7,50 €</b>
HPF-GKA-O-602	3/4"	6000PSİ	41,3mm	27,2mm	50,8mm x 23,8mm	420 Bar	24,99x3,53	M10X35	<b>8,50 €</b>
HPF-GKA-O-603	1"	6000PSİ	47,6mm	34mm	57,2mm x 27,8mm	420 Bar	32,92x3,53	M12X45	<b>10,00 €</b>
HPF-GKA-O-604	1 1/4"	6000PSİ	54mm	42,6mm	66,6mm x 31,8mm	420 Bar	37,69x3,53	M14X50	<b>13,00 €</b>
HPF-GKA-O-605	1 1/2"	6000PSİ	63,5mm	48,8mm	79,3mm x 36,5mm	420 Bar	47,22x3,53	M16X55	<b>20,00 €</b>
HPF-GKA-O-606	2"	6000PSİ	79,4mm	60,9mm	96,8mm x 44,5mm	420 Bar	56,74x3,53	M20X70	<b>30,00 €</b>

**6000PSİ GEÇME KAYNAKLI ADAPTÖR O-RİNG'SİZ**

KOD	ÖLÇÜ	FLANŞ ÖLÇÜSÜ	BORU Q	EKSEN ÖLÇÜSÜ	ÇALIŞMA BASINCI	CİVATA	FİYAT	
HPF-GKA-601	1/2"	6000PSİ	32mm	21,5mm	40,5mm x 18,2mm	420 Bar	M8X30	<b>7,50 €</b>
HPF-GKA-602	3/4"	6000PSİ	41,3mm	27,2mm	50,8mm x 23,8mm	420 Bar	M10X35	<b>8,50 €</b>
HPF-GKA-603	1"	6000PSİ	47,6mm	34mm	57,2mm x 27,8mm	420 Bar	M12X45	<b>10,00 €</b>
HPF-GKA-604	1 1/4"	6000PSİ	54mm	42,6mm	66,6mm x 31,8mm	420 Bar	M14X50	<b>13,00 €</b>
HPF-GKA-605	1 1/2"	6000PSİ	63,5mm	48,8mm	79,3mm x 36,5mm	420 Bar	M16X55	<b>20,00 €</b>
HPF-GKA-606	2"	6000PSİ	79,4mm	60,9mm	96,8mm x 44,5mm	420 Bar	M20X70	<b>30,00 €</b>

**HPF-AKA-O**

**ALIN KAYNAKLI  
ADAPTÖR O-RİNGLİ**



**ALIN KAYNAKLI  
ADAPTÖR O-RİNGSİZ**

**HPF-AKA**

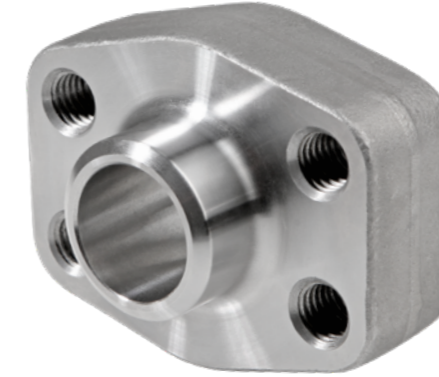

**3000PSİ ALIN KAYNAKLI ADAPTÖR O-RİNGLİ**

KOD	ÖLÇÜ	FLANŞ ÖLÇÜSÜ	BORU Q	EKSEN ÖLÇÜSÜ	ÇALIŞMA BASINCI	O-RİNG	CİVATA	FİYAT	
HPF-AKA-O-301	1/2"	3000PSİ	30,2mm	21,5mm	38,1mm x 17,5mm	350 Bar	18,64x3,53	M8X30	<b>6,00 €</b>
HPF-AKA-O-302	3/4"	3000PSİ	38,1mm	28mm	47,6mm x 22,3mm	350 Bar	24,99x3,53	M10X35	<b>7,50 €</b>
HPF-AKA-O-303	1"	3000PSİ	44,4mm	34mm	52,4mm x 26,2mm	315 Bar	32,92x3,53	M10X35	<b>8,00 €</b>
HPF-AKA-O-304	1 1/4"	3000PSİ	50,8mm	42,8mm	58,7mm x 30,2mm	250 Bar	37,69x3,53	M10X40	<b>10,00 €</b>
HPF-AKA-O-305	1 1/2"	3000PSİ	60,3mm	48,6mm	69,9mm x 35,7mm	200 Bar	47,22x3,53	M12X45	<b>12,00 €</b>
HPF-AKA-O-306	2"	3000PSİ	71,4mm	61mm	77,8mm x 42,9mm	200 Bar	56,74x3,53	M12X45	<b>15,00 €</b>
HPF-AKA-O-307	2 1/2"	3000PSİ	84,1mm	76,6mm	89mm x 50,8mm	160 Bar	69,44x3,53	M12X45	<b>24,60 €</b>
HPF-AKA-O-308	3"	3000PSİ	101,6mm	89mm	106,4mm x 62mm	100 Bar	85,32x3,53	M16X50	<b>38,00 €</b>

**3000PSİ ALIN KAYNAKLI ADAPTÖR O-RİNG'SİZ**

KOD	ÖLÇÜ	FLANŞ ÖLÇÜSÜ	BORU Q	EKSEN ÖLÇÜSÜ	ÇALIŞMA BASINCI	CİVATA	FİYAT	
HPF-AKA-301	1/2"	3000PSİ	30,2mm	21,5mm	38,1mm x 17,5mm	350 Bar	M8X30	<b>6,00 €</b>
HPF-AKA-302	3/4"	3000PSİ	38,1mm	28mm	47,6mm x 22,3mm	350 Bar	M10X35	<b>7,50 €</b>
HPF-AKA-303	1"	3000PSİ	44,4mm	34mm	52,4mm x 26,2mm	315 Bar	M10X35	<b>8,00 €</b>
HPF-AKA-304	1 1/4"	3000PSİ	50,8mm	42,8mm	58,7mm x 30,2mm	250 Bar	M10X40	<b>10,00 €</b>
HPF-AKA-305	1 1/2"	3000PSİ	60,3mm	48,6mm	69,9mm x 35,7mm	200 Bar	M12X45	<b>12,00 €</b>
HPF-AKA-306	2"	3000PSİ	71,4mm	61mm	77,8mm x 42,9mm	200 Bar	M12X45	<b>15,00 €</b>
HPF-AKA-307	2 1/2"	3000PSİ	84,1mm	76,6mm	89mm x 50,8mm	160 Bar	M12X45	<b>24,60 €</b>
HPF-AKA-308	3"	3000PSİ	101,6mm	89mm	106,4mm x 62mm	100 Bar	M16X50	<b>38,00 €</b>

**6000PSİ ALIN KAYNAKLI ADAPTÖR O-RİNGLİ**

KOD	ÖLÇÜ	FLANŞ ÖLÇÜSÜ	BORU Q	EKSEN ÖLÇÜSÜ	ÇALIŞMA BASINCI	O-RİNG	CİVATA	FİYAT	
HPF-AKA-O-601	1/2"	6000PSİ	32mm	21,5mm	40,5mm x 18,2mm	420 Bar	18,64x3,53	M8X30	<b>7,50 €</b>
HPF-AKA-O-602	3/4"	6000PSİ	41,3mm	28mm	50,8mm x 23,8mm	420 Bar	24,99x3,53	M10X35	<b>8,50 €</b>
HPF-AKA-O-603	1"	6000PSİ	47,6mm	34mm	57,2mm x 27,8mm	420 Bar	32,92x3,53	M12X45	<b>10,00 €</b>
HPF-AKA-O-604	1 1/4"	6000PSİ	54mm	42,8mm	66,6mm x 31,8mm	420 Bar	37,69x3,53	M14X50	<b>13,00 €</b>
HPF-AKA-O-605	1 1/2"	6000PSİ	63,5mm	48,6mm	79,3mm x 36,5mm	420 Bar	47,22x3,53	M16X55	<b>20,00 €</b>
HPF-AKA-O-606	2"	6000PSİ	79,4mm	61mm	96,8mm x 44,5mm	420 Bar	56,74x3,53	M20X70	<b>30,00 €</b>

**6000PSİ ALIN KAYNAKLI ADAPTÖR O-RİNG'SİZ**

KOD	ÖLÇÜ	FLANŞ ÖLÇÜSÜ	BORU Q	EKSEN ÖLÇÜSÜ	ÇALIŞMA BASINCI	CİVATA	FİYAT	
HPF-AKA-601	1/2"	6000PSİ	32mm	21,5mm	40,5mm x 18,2mm	420 Bar	M8X30	<b>7,50 €</b>
HPF-AKA-602	3/4"	6000PSİ	41,3mm	28mm	50,8mm x 23,8mm	420 Bar	M10X35	<b>8,50 €</b>
HPF-AKA-603	1"	6000PSİ	47,6mm	34mm	57,2mm x 27,8mm	420 Bar	M12X45	<b>10,00 €</b>
HPF-AKA-604	1 1/4"	6000PSİ	54mm	42,8mm	66,6mm x 31,8mm	420 Bar	M14X50	<b>13,00 €</b>
HPF-AKA-605	1 1/2"	6000PSİ	63,5mm	48,6mm	79,3mm x 36,5mm	420 Bar	M16X55	<b>20,00 €</b>
HPF-AKA-606	2"	6000PSİ	79,4mm	61mm	96,8mm x 44,5mm	420 Bar	M20X70	<b>30,00 €</b>

**HPF-KF-O**

**KÖR FLANŞ O-RİNGLİ**



**KÖR FLANŞ O-RİNGSİZ**

**HPF-KF**



**3000PSİ KÖR FLANŞ O-RİNGLİ**

KOD	ÖLÇÜ	FLANŞ ÖLÇÜSÜ	EKSEN ÖLÇÜSÜ	ÇALIŞMA BASINCI	O-RİNG	CİVATA	FİYAT	
HPF-KF-O-301	1/2"	3000PSİ	30,2mm	38,1mm x 17,5mm	350 Bar	18,64x3,53	M8X30	<b>3,80 €</b>
HPF-KF-O-302	3/4"	3000PSİ	38,1mm	47,6mm x 22,3mm	350 Bar	24,99x3,53	M10X35	<b>4,80 €</b>
HPF-KF-O-303	1"	3000PSİ	44,4mm	52,4mm x 26,2mm	315 Bar	32,92x3,53	M10X35	<b>5,80 €</b>
HPF-KF-O-304	1 1/4"	3000PSİ	50,8mm	58,7mm x 30,2mm	250 Bar	37,69x3,53	M10X40	<b>7,00 €</b>
HPF-KF-O-305	1 1/2"	3000PSİ	60,3mm	69,9mm x 35,7mm	200 Bar	47,22x3,53	M12X45	<b>12,00 €</b>
HPF-KF-O-306	2"	3000PSİ	71,4mm	77,8mm x 42,9mm	200 Bar	56,74x3,53	M12X45	<b>13,50 €</b>
HPF-KF-O-307	2 1/2"	3000PSİ	84,1mm	89mm x 50,8mm	160 Bar	69,44x3,53	M12X45	<b>16,00 €</b>
HPF-KF-O-308	3"	3000PSİ	101,6mm	106,4mm x 62mm	100 Bar	85,32x3,53	M16X50	<b>26,00 €</b>

**3000PSİ KÖR FLANŞ O-RİNG'SİZ**

KOD	ÖLÇÜ	FLANŞ ÖLÇÜSÜ	EKSEN ÖLÇÜSÜ	ÇALIŞMA BASINCI	CİVATA	FİYAT	
HPF-KF-301	1/2"	3000PSİ	30,2mm	38,1mm x 17,5mm	350 Bar	M8X30	<b>4,50 €</b>
HPF-KF-302	3/4"	3000PSİ	38,1mm	47,6mm x 22,3mm	350 Bar	M10X35	<b>5,50 €</b>
HPF-KF-303	1"	3000PSİ	44,4mm	52,4mm x 26,2mm	315 Bar	M10X35	<b>6,50 €</b>
HPF-KF-304	1 1/4"	3000PSİ	50,8mm	58,7mm x 30,2mm	250 Bar	M10X40	<b>8,00 €</b>
HPF-KF-305	1 1/2"	3000PSİ	60,3mm	69,9mm x 35,7mm	200 Bar	M12X45	<b>13,00 €</b>
HPF-KF-306	2"	3000PSİ	71,4mm	77,8mm x 42,9mm	200 Bar	M12X45	<b>15,00 €</b>
HPF-KF-307	2 1/2"	3000PSİ	84,1mm	89mm x 50,8mm	160 Bar	M12X45	<b>17,50 €</b>
HPF-KF-308	3"	3000PSİ	101,6mm	106,4mm x 62mm	100 Bar	M16X50	<b>28,00 €</b>

**6000PSİ KÖR FLANŞ O-RİNGLİ**

KOD	ÖLÇÜ	FLANŞ ÖLÇÜSÜ	EKSEN ÖLÇÜSÜ	ÇALIŞMA BASINCI	O-RİNG	CİVATA	FİYAT	
HPF-KF-O-601	1/2"	6000PSİ	32mm	40,5mm x 18,2mm	420 Bar	18,64x3,53	M8X30	<b>4,00 €</b>
HPF-KF-O-602	3/4"	6000PSİ	41,3mm	50,8mm x 23,8mm	420 Bar	24,99x3,53	M10X35	<b>7,50 €</b>
HPF-KF-O-603	1"	6000PSİ	47,6mm	57,2mm x 27,8mm	420 Bar	32,92x3,53	M12X45	<b>10,00 €</b>
HPF-KF-O-604	1 1/4"	6000PSİ	54mm	66,6mm x 31,8mm	420 Bar	37,69x3,53	M14X50	<b>14,00 €</b>
HPF-KF-O-605	1 1/2"	6000PSİ	63,5mm	79,3mm x 36,5mm	420 Bar	47,22x3,53	M16X55	<b>20,00 €</b>
HPF-KF-O-606	2"	6000PSİ	79,4mm	96,8mm x 44,5mm	420 Bar	56,74x3,53	M20X70	<b>28,00 €</b>

**6000PSİ KÖR FLANŞ O-RİNG'SİZ**

KOD	ÖLÇÜ	FLANŞ ÖLÇÜSÜ	EKSEN ÖLÇÜSÜ	ÇALIŞMA BASINCI	CİVATA	FİYAT	
HPF-KF-601	1/2"	6000PSİ	32mm	40,5mm x 18,2mm	420 Bar	M8X30	<b>5,00 €</b>
HPF-KF-602	3/4"	6000PSİ	41,3mm	50,8mm x 23,8mm	420 Bar	M10X35	<b>8,00 €</b>
HPF-KF-603	1"	6000PSİ	47,6mm	57,2mm x 27,8mm	420 Bar	M12X45	<b>11,00 €</b>
HPF-KF-604	1 1/4"	6000PSİ	54mm	66,6mm x 31,8mm	420 Bar	M14X50	<b>15,00 €</b>
HPF-KF-605	1 1/2"	6000PSİ	63,5mm	79,3mm x 36,5mm	420 Bar	M16X55	<b>22,00 €</b>
HPF-KF-606	2"	6000PSİ	79,4mm	96,8mm x 44,5mm	420 Bar	M20X70	<b>32,00 €</b>

## PRİZ REKORLARI & ADAPTÖRLER

MALZEME KODU	ÜRÜN ADI	BİRİM FİYATI
PR-1	R1/8 M16x2 PRİZ REKORU	6,30 €
PR-2	R1/4 M16x2 PRİZ REKORU	6,00 €
PR-3	R3/8 M16x2 PRİZ REKORU	6,50 €
PR-4	1/8 NPT M16x2 PRİZ REKORU	7,50 €
PR-5	R1/4 M16x1.5 PRİZ REKORU	7,50 €
PR-6	R1/4 M12x1.65 PRİZ REKORU	7,50 €
PR-7	M8x1 M16x2 PRİZ REKORU	7,00 €
PR-8	M10x1 M16x2 PRİZ REKORU	7,00 €
PR-9	M10x1.25 M16x2 PRİZ REKORU	7,00 €
PR-10	M12x1.5 M16x2 PRİZ REKORU	7,00 €
PR-11	M14x1.5 M16x2 PRİZ REKORU	7,00 €
PR-12	M16x1.5 M16x2 PRİZ REKORU	7,00 €
PR-13	5/16 UNF M16x2 PRİZ REKORU	7,00 €
PR-14	7/16 UNF M16x2 PRİZ REKORU	7,00 €
PR-15	1/2 UNF M16x2 PRİZ REKORU	7,00 €
PR-16	9/16 UNF M16x2 PRİZ REKORU	7,00 €
PR-17	6L M16x2 TERS PRİZ REKORU	8,50 €
PR-18	8L M16x2 TERS PRİZ REKORU	8,50 €
PR-19	10L M16x2 TERS PRİZ REKORU	8,50 €
PR-20	12L M16x2 TERS PRİZ REKORU	8,50 €
PR-21	16S M16x2 TERS PRİZ REKORU	8,50 €
PR-22	R1/4 M16x2 ADAPTÖR	8,50 €
PR-23	R1/2 M16x2 ADAPTÖR	11,00 €
PR-24	R1/4 M16x2 PERDE GEÇİŞ	8,50 €
PR-25	R1/2 M16x2 PERDE GEÇİŞ	11,00 €

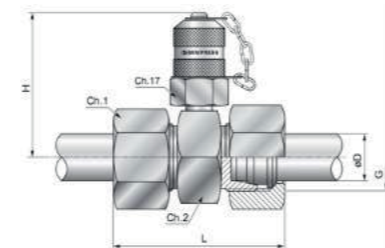
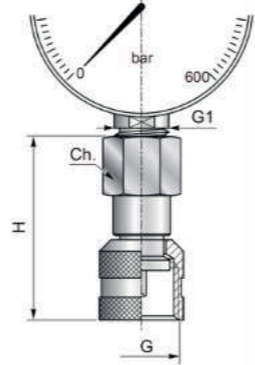
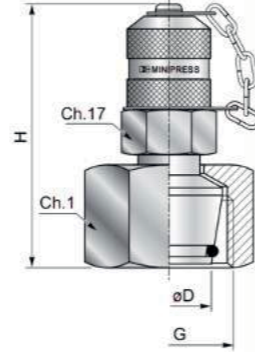
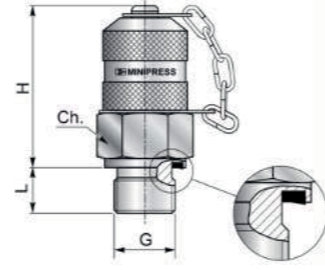
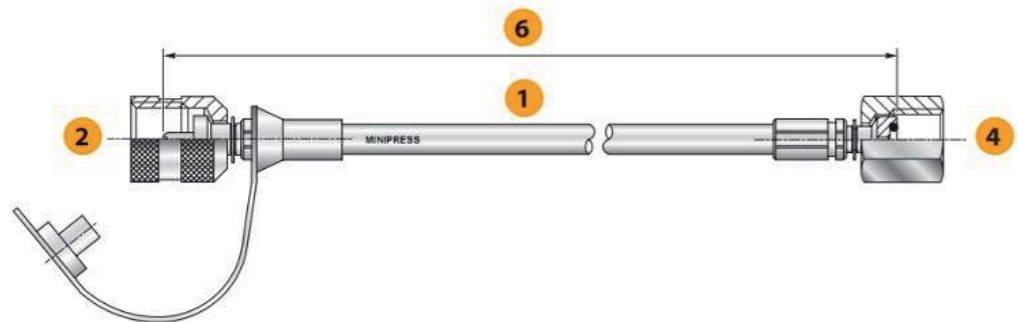

## DN2 TEST HORTUMU BAŞLIKLARI HAZIR PRESLENMİŞ DN2 HORTUMLAR

MALZEME KODU	ÜRÜN ADI	BİRİM FİYATI
DN2-1	DN2 M16x2 SOMUNLU DÜZ	€ 2,48
DN2-2	DN2 R1/4 SOMUNLU DÜZ	€ 2,53
DN2-3	DN2 M16x1.5 SOMUNLU DÜZ	€ 4,18
DN2-4	DN2 M12.65 x 1.5 SOMUNLU DÜZ	€ 4,35
DN2-5	DN2 M12x1.5 6L SOMUNLU DÜZ	€ 2,09
DN2-6	DN2 M14x1.5 8L SOMUNLU DÜZ	€ 2,25
DN2-7	DN2 M16x1.5 10L SOMUNLU DÜZ	€ 2,43
DN2-8	DN2 R1/8 SOMUNLU DÜZ	€ 2,59
DN2-9	DN2 R1/4 SOMUNLU DÜZ	€ 2,43
DN2-10	DN2 7/16 UNF SOMUNLU DÜZ	€ 2,76
DN2-11	DN2 9/16 UNF SOMUNLU DÜZ	€ 2,98
DN2-12	DN2 6mm BORU UÇLU DÜZ	€ 1,63
DN2-13	DN2 8mm BORU UÇLU DÜZ	€ 1,69
DN2-14	DN2 8mm HALKA	€ 6,38
DN2-15	DN2 10mm HALKA	€ 6,47
DN2-16	DN2 PLUG-İN BAĞLANTI	€ 2,14
DN2-17	DN2 M16x2 SOMUNLU 90°	€ 7,02
DN2-18	DN2 R1/4 SOMUNLU 90°	€ 7,27
DN2-19	DN2 M12x1.5 6L SOMUNLU 90°	€ 5,24
DN2-20	DN2 M14x1.5 8L SOMUNLU 90°	€ 5,66
DN2-21	DN2 M16x1.5 10L SOMUNLU 90°	€ 6,07
DN2-22	DN2 6mm BORU UÇLU 90°	€ 4,04
DN2-23	DN2 8mm BORU UÇLU 90°	€ 4,29
DN2-24	DN2 SOKET	€ 0,33
DN2-25	DN2 HORTUM 50cm	€ 7,37
DN2-26	DN2 HORTUM 100cm	€ 9,19
DN2-27	DN2 HORTUM 150cm	€ 10,70
DN2-28	DN2 HORTUM 200cm	€ 12,32
DN2-29	DN2 HORTUM 250cm	€ 14,00
DN2-30	DN2 HORTUM 300cm	€ 15,60
DN2-31	DN2 HORTUM 400cm	€ 18,90
DN2-32	DN2 HORTUM 500cm	€ 22,22

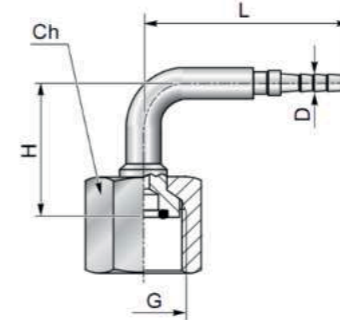
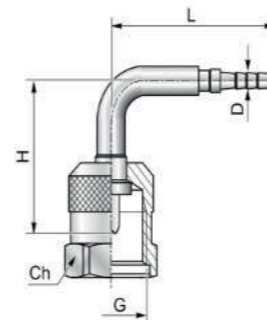
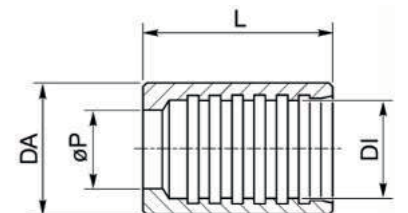
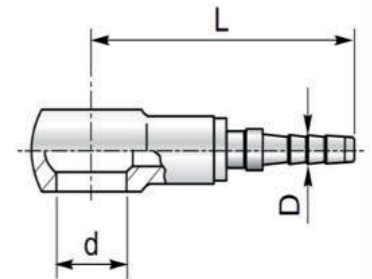
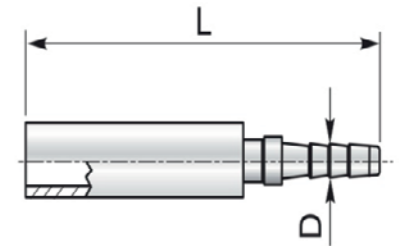
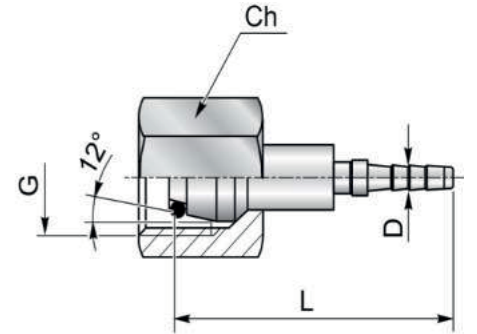
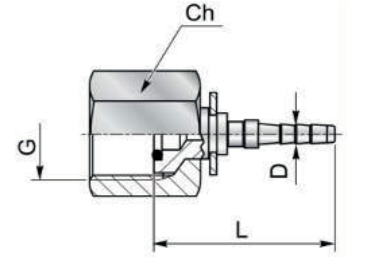
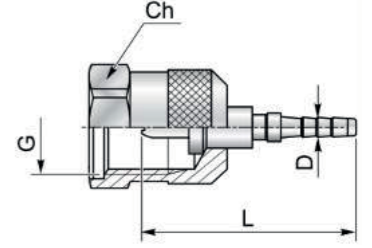







## QC SERİSİ QCC SERİSİ

### POPETLİ HİDROLİK OTOMATİK REKOR QC SERİSİ

ÜRÜN KODU	ÖLÇÜSÜ	ÇALIŞMA BASINCI (BAR)	FİYATI €
QC-101-A	1/4 BSP (DİŞİ)	350	6,82 €
QC-101-B	1/4 BSP (ERKEK)	350	3,67 €
QC-102-A	3/8 BSP (DİŞİ)	330	6,98 €
QC-102-B	3/8 BSP (ERKEK)	330	3,76 €
QC-103-A	1/2 BSP (DİŞİ)	320	7,55 €
QC-103-B	1/2 BSP (ERKEK)	320	3,15 €
QC-103-A (T)	1/2 BSP (DİŞİ) TOZ KAPAKLI	320	8,47 €
QC-103-B (T)	1/2 BSP (ERKEK) TOZ KAPAKLI	320	3,38 €
QC-104-A	3/4 BSP (DİŞİ)	280	12,64 €
QC-104-B	3/4 BSP (ERKEK)	280	6,80 €
QC-105-A	1" BSP (DİŞİ)	250	17,89 €
QC-105-B	1" BSP (ERKEK)	250	9,63 €
QC-106-A	1-1/4 BSP (DİŞİ)	230	24,53 €
QC-106-B	1-1/4 BSP (ERKEK)	230	13,24 €
QC-107-A	1-1/2 BSP (DİŞİ)	220	55,50 €
QC-107-B	1-1/2 BSP (ERKEK)	220	38,29 €
QC-108-A	2" BSP (DİŞİ)	200	133,20 €
QC-108-B	2" BSP (ERKEK)	200	83,25 €



## QC-P SERİSİ

### PIRİNÇ HİDROLİK OTOMATİK RAKOR QC-P SERİSİ (VİTONLU)

ÜRÜN KODU	ÖLÇÜSÜ	ÇALIŞMA BASINCI (BAR)	FİYATI €
QC-P101-A	1/4 BSP (DİŞİ)	190	21,09 €
QC-P101-B	1/4 BSP (ERKEK)	190	14,43 €
QC-P102-A	3/8 BSP (DİŞİ)	175	23,87 €
QC-P102-B	3/8 BSP (ERKEK)	175	15,32 €
QC-P103-A	1/2 BSP (DİŞİ)	160	26,64 €
QC-P103-B	1/2 BSP (ERKEK)	160	16,65 €
QC-P104-A	3/4 BSP (DİŞİ)	130	42,18 €
QC-P104-B	3/4 BSP (ERKEK)	130	27,75 €
QC-P105-A	1" BSP (DİŞİ)	100	68,82 €
QC-P105-B	1" BSP (ERKEK)	100	44,40 €
QC-P106-A	1-1/4 BSP (DİŞİ)	80	123,10 €
QC-P106-B	1-1/4 BSP (ERKEK)	80	83,25 €
QC-P107-A	1-1/2 BSP (DİŞİ)	65	249,75 €
QC-P107-B	1-1/2 BSP (ERKEK)	65	166,50 €
QC-P108-A	2" BSP (DİŞİ)	50	510,60 €
QC-P108-B	2" BSP (ERKEK)	50	344,10 €



## QC-V SERİSİ

### VİTONLU HİDROLİK OTOMATİK RAKOR QC-V SERİSİ

ÜRÜN KODU	ÖLÇÜSÜ	ÇALIŞMA BASINCI (BAR)	FİYATI €
QC-V101-A	1/4 BSP (DİŞİ)	350	8,50 €
QC-V101-B	1/4 BSP (ERKEK)	350	5,66 €
QC-V102-A	3/8 BSP (DİŞİ)	330	9,44 €
QC-V102-B	3/8 BSP (ERKEK)	330	6,11 €
QC-V103-A	1/2 BSP (DİŞİ)	320	10,56 €
QC-V103-B	1/2 BSP (ERKEK)	320	7,04 €
QC-V104-A	3/4 BSP (DİŞİ)	280	18,99 €
QC-V104-B	3/4 BSP (ERKEK)	280	12,65 €
QC-V105-A	1" BSP (DİŞİ)	250	27,67 €
QC-V105-B	1" BSP (ERKEK)	250	18,44 €
QC-V106-A	1-1/4 BSP (DİŞİ)	230	40,70 €
QC-V106-B	1-1/4 BSP (ERKEK)	230	27,14 €
QC-V107-A	1-1/2 BSP (DİŞİ)	220	85,93 €
QC-V107-B	1-1/2 BSP (ERKEK)	220	57,28 €
QC-V108-A	2" BSP (DİŞİ)	200	166,18 €
QC-V108-B	2" BSP (ERKEK)	200	110,78 €

\* -30 °C ile +225 °C de kullanıma uygun





## QCF SERİSİ

### DÜZ ALINLI HIDROLİK OTOMATİK RAKOR QCF SERİSİ

ÜRÜN KODU	ÖLÇÜSÜ	ÇALIŞMA BASINCI (BAR)	FİYATI €
QCF-102-A	3/8 BSP (DİŞİ)	370	17,32 €
QCF-102-B	3/8 BSP (ERKEK)	370	11,55 €
QCF-103-A	1/2 BSP (DİŞİ)	370	17,32 €
QCF-103-B	1/2 BSP (ERKEK)	370	11,55 €
QCF-104-A	3/4 BSP (DİŞİ)	350	27,82 €
QCF-104-B	3/4 BSP (ERKEK)	350	18,48 €
QCF-105-A	1" BSP (DİŞİ)	330	38,46 €
QCF-105-B	1" BSP (ERKEK)	330	25,64 €
QCF-A106-A	1 1/4" BSP (DİŞİ)	380	73,43 €
QCF-A106-B	1 1/4" BSP (ERKEK)	380	46,62 €
QCF-U-204A	1"1/16 UNF (DİŞİ)	350	53,50 €
QCF-U-204B	1"1/16 UNF (ERKEK)	350	34,50 €

## QCFA SERİSİ KIRICILARA ÖZEL

### AĞIR SERİ DÜZ ALINLI HIDROLİK OTOMATİK RAKOR QCFA SERİSİ

ÜRÜN KODU	ÖLÇÜSÜ	ÇALIŞMA BASINCI (BAR)	FİYATI €
QCFA-102-A	3/8 BSP (DİŞİ)	450	25,30 €
QCFA-102-B	3/8 BSP (ERKEK)	450	17,00 €
QCFA-103-A	1/2 BSP (DİŞİ)	450	26,56 €
QCFA-103-B	1/2 BSP (ERKEK)	450	17,85 €
QCFA-104-A	3/4 BSP (DİŞİ)	400	39,63 €
QCFA-104-B	3/4 BSP (ERKEK)	400	25,64 €
QCFA-105-A	1" BSP (DİŞİ)	380	62,35 €
QCFA-105-B	1" BSP (ERKEK)	380	41,96 €

\* Kırıcılara özel



## QC-VYB SERİSİ

### VIDALI YÜKSEK BASINÇLI HIDROLİK OTOMATİK RAKOR QC-VYB SERİSİ

ÜRÜN KODU	ÖLÇÜSÜ	ÇALIŞMA BASINCI (BAR)	FİYATI €
QC-VYB-101A	1/4 BSP (DİŞİ)	500	14,53 €
QC-VYB-101B	1/4 BSP (ERKEK)	500	7,82 €
QC-VYB-102A	3/8 BSP (DİŞİ)	480	14,85 €
QC-VYB-102B	3/8 BSP (ERKEK)	480	8,00 €
QC-VYB-103A	1/2 BSP (DİŞİ)	450	16,94 €
QC-VYB-103B	1/2 BSP (ERKEK)	450	6,50 €
QC-VYB-104A	3/4 BSP (DİŞİ)	410	26,87 €
QC-VYB-104B	3/4 BSP (ERKEK)	410	14,47 €
QC-VYB-105A	1" BSP (DİŞİ)	380	38,06 €
QC-VYB-105B	1" BSP (ERKEK)	380	20,49 €

## QC-S SERİSİ

### AISI 316-L PASLANMAZ HIDROLİK OTOMATİK RAKOR QC-S SERİSİ

ÜRÜN KODU	ÖLÇÜSÜ	ÇALIŞMA BASINCI (BAR)	FİYATI €
QC-S102A	3/8 BSP (DİŞİ)	330	44,10 €
QC-S102B	3/8 BSP (ERKEK)	330	29,97 €
QC-S103A	1/2 BSP (DİŞİ)	320	45,51 €
QC-S103B	1/2 BSP (ERKEK)	320	34,41 €
QC-S104A	3/4 BSP (DİŞİ)	280	94,91 €
QC-S104B	3/4 BSP (ERKEK)	280	63,27 €
QC-S105A	1" BSP (DİŞİ)	250	144,30 €
QC-S105B	1" BSP (ERKEK)	250	99,90 €

\* Sızdırmazlık elemanı viton



## DNB SERİSİ

### HİDROLİK DÖNER BAĞLANTI REKORLARI DÜZ TİP | DNB SERİSİ

ÜRÜN KODU	ÖLÇÜSÜ	ÇALIŞMA BASINCI (BAR)	FİYATI (EURO)
DNB-14N	1/4" BSP	450	€ 11,97
DNB-38N	3/8" BSP	450	€ 13,02
DNB-12N	1/2" BSP	410	€ 15,23
DNB-34N	3/4" BSP	360	€ 22,98
DNB-1N	1" BSP	330	€ 34,96



## DNB - D SERİSİ

### HİDROLİK DÖNER BAĞLANTI REKORLARI DIRSEKTİP DNB-D SERİSİ

ÜRÜN KODU	ÖLÇÜSÜ	ÇALIŞMA BASINCI (BAR)	FİYATI (EURO)
DNB-D-14N	1/4" BSP	450	€ 13,00
DNB-D-38N	3/8" BSP	450	€ 15,23
DNB-D-12N	1/2" BSP	410	€ 18,60
DNB-D-34N	3/4" BSP	360	€ 33,14
DNB-D-1N	1" BSP	330	€ 46,21



## HPV SERİSİ

### HİDROLİK HORTUM PATLATMA EMNİYET VALFİ (HPV SERİSİ)

ÜRÜN KODU	ÖLÇÜSÜ	ÇALIŞMA BASINCI (BAR)	FİYATI (EURO)
HPV-101	1/4" BSP	420	€ 10,60
HPV-101K	1/4" BSP KATRIÇ	420	€ 6,66
HPV-102	3/8" BSP	420	€ 9,44
HPV-102K	3/8" BSP KATRIÇ	420	€ 5,77
HPV-103	1/2" BSP	400	€ 11,10
HPV-103K	1/2" BSP KATRIÇ	400	€ 6,66
HPV-104	3/4" BSP	380	€ 15,54
HPV-104K	3/4" BSP KATRIÇ	380	€ 9,66
HPV-105	1" BSP	350	€ 26,31
HPV-105K	1" BSP KATRIÇ	350	€ 16,65



## FUV SERİSİ

### ÇEKİLİ HIZ AYAR VALFİ

### FUV SERİSİ ÇEKİLİ HIZ AYAR VALFLERİ

ÜRÜN KODU	ÖLÇÜSÜ	ÇALIŞMA BASINCI (BAR)	FİYATI (EURO)
OL-140FUV	1/4"	350	€ 18,61
OL-380FUV	3/8"	350	€ 20,41
OL-120FUV	1/2"	350	€ 26,00



## FCV SERİSİ

### ÇEKSİZ HIZ AYAR VALFİ

### FCV SERİSİ ÇEKSİZ HIZ AYAR VALFLERİ

ÜRÜN KODU	ÖLÇÜSÜ	ÇALIŞMA BASINCI (BAR)	FİYATI (EURO)
OL-140FCV	1/4"	350	€ 16,70
OL-380FCV	3/8"	350	€ 17,65
OL-120FCV	1/2"	350	€ 24,24



**KV-2 SERİSİ**  
2 YOLLU KÜRESEL VANALAR

2 YOLLU HİDROLİK KÜRESEL VANA SERİSİ

ÜRÜN KODU	ÜRÜN ADI	ÇALIŞMA BASINCI (BAR)	FİYATI €
KV-2401	1/4 HİDROLİK KÜRESEL VANA	500	11,76 €
KV-2402	3/8 HİDROLİK KÜRESEL VANA	500	12,71 €
KV-2403	1/2 HİDROLİK KÜRESEL VANA	500	14,55 €
KV-2404	3/4 HİDROLİK KÜRESEL VANA	400	26,09 €
KV-2405	1" HİDROLİK KÜRESEL VANA	400	31,64 €
KV-2406	1-1/4 HİDROLİK KÜRESEL VANA	400	42,18 €
KV-2407	1-1/2 HİDROLİK KÜRESEL VANA	350	45,96 €

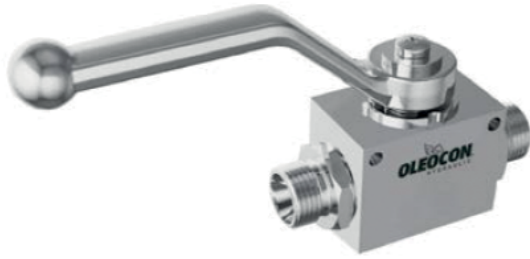

**KV-2M SERİSİ**  
2 YOLLU METRİK KÜRESEL VANA

2 YOLLU METRİK KÜRESEL VANA SERİSİ

ÜRÜN KODU	ÜRÜN ADI	ÇALIŞMA BASINCI (BAR)	FİYATI €
KV2-M401	M14x1,5 HİDROLİK 2 YOLLU KÜRESEL VANA	500	14,77 €
KV2-M402	M16x1,5 HİDROLİK 2 YOLLU KÜRESEL VANA	500	13,99 €
KV2-M403	M18x1,5 HİDROLİK 2 YOLLU KÜRESEL VANA	500	15,21 €
KV2-M404	M20x1,5 HİDROLİK 2 YOLLU KÜRESEL VANA	500	16,66 €
KV2-M405	M22x1,5 HİDROLİK 2 YOLLU KÜRESEL VANA	500	18,15 €
KV2-M406	M24x1,5 HİDROLİK 2 YOLLU KÜRESEL VANA	500	17,76 €
KV2-M407	M26x1,5 HİDROLİK 2 YOLLU KÜRESEL VANA	500	22,20 €
KV2-M408	M30x2 HİDROLİK 2 YOLLU KÜRESEL VANA	400	29,97 €
KV2-M409	M36x2 HİDROLİK 2 YOLLU KÜRESEL VANA	400	48,29 €
KV2-M410	M42x2 HİDROLİK 2 YOLLU KÜRESEL VANA	400	44,40 €
KV2-M411	M45x2 HİDROLİK 2 YOLLU KÜRESEL VANA	400	45,51 €
KV2-M412	M52x2 HİDROLİK 2 YOLLU KÜRESEL VANA	400	53,28 €

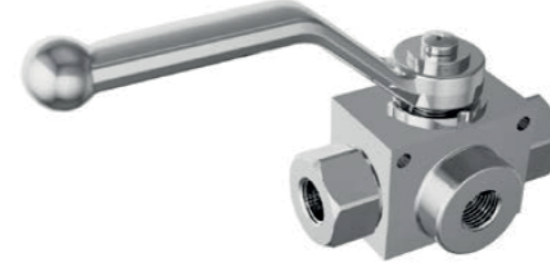

**KV-3 SERİSİ**  
3 YOLLU KÜRESEL VANALAR

3 YOLLU L TİPİ HİDROLİK KÜRESEL VANA SERİSİ

ÜRÜN KODU	ÜRÜN ADI	ÇALIŞMA BASINCI (BAR)	FİYATI
KV3L-401	1/4 HİDROLİK KÜRESEL VANA	500	24,42 €
KV3L-402	3/8 HİDROLİK KÜRESEL VANA	500	26,09 €
KV3L-403	1/2 HİDROLİK KÜRESEL VANA	500	29,97 €
KV3L-404	3/4 HİDROLİK KÜRESEL VANA	400	52,17 €
KV3L-405	1" HİDROLİK KÜRESEL VANA	400	61,05 €
KV3L-406	1-1/4 HİDROLİK KÜRESEL VANA	400	77,145 €
KV3L-407	1-1/2 HİDROLİK KÜRESEL VANA	380	85,47 €

3 YOLLU T TİPİ HİDROLİK KÜRESEL VANA SERİSİ

ÜRÜN KODU	ÜRÜN ADI	ÇALIŞMA BASINCI (BAR)	FİYATI
KV3T-401	1/4 HİDROLİK KÜRESEL VANA	500	31,64 €
KV3T-402	3/8 HİDROLİK KÜRESEL VANA	500	34,97 €
KV3T-403	1/2 HİDROLİK KÜRESEL VANA	500	44,40 €
KV3T-404	3/4 HİDROLİK KÜRESEL VANA	400	65,49 €
KV3T-405	1" HİDROLİK KÜRESEL VANA	400	83,25 €
KV3T-406	1-1/4 HİDROLİK KÜRESEL VANA	400	96,57 €
KV3T-407	1-1/2 HİDROLİK KÜRESEL VANA	380	105,45 €



**KV-K SERİSİ**  
KÜRESEL VANA KOLU

3 YOLLU T TİPİ HİDROLİK KÜRESEL VANA SERİSİ

ÜRÜN KODU	ÜRÜN ADI	FİYATI
KV-KK	HİDROLİK KÜRESEL VANA KOLU (KÜÇÜK)	3,30 €
KV-BK	HİDROLİK KÜRESEL VANA KOLU (BÜYÜK)	4,40 €



## CV SERİSİ POPETLİ HAT TİPİ ÇEK VALFLER

### OLEOCON HİDROLİK HAT TİPİ ÇEK VALF SERİSİ

ÜRÜN KODU	ÖLÇÜSÜ	ÇALIŞMA BASINCI (BAR)	FİYATI
CV-201	1/4" BSP	450	6,66 €
CV-202	3/8" BSP	450	7,104 €
CV-203	1/2" BSP	400	7,215 €
CV-204	3/4" BSP	380	14,99 €
CV-205	1" BSP	350	26,085€
CV-206	1 1/4" BSP	350	36,63 €
CV-207	1 1/2" BSP	280	44,40 €
CV-208	2" BSP	260	62,16 €



## CV-S SERİSİ PASLANMAZ HAT TİPİ ÇEK VALFLER

### OLEOCON HİDROLİK AISI 316 L KALİTE PASLANMAZ ÇEK VALF SERİSİ (VİTONLU)

ÜRÜN KODU	ÖLÇÜSÜ	ÇALIŞMA BASINCI (BAR)	FİYATI
CV-202S	3/8" BSP	450	46,62 €
CV-203S	1/2" BSP	400	48,28 €
CV-204S	3/4" BSP	380	101,01 €
CV-205S	1" BSP	350	175,38 €
CV-206S	1 1/4" BSP	350	242,53 €
CV-207S	1 1/2" BSP	280	287,50 €
CV-208S	2" BSP	260	404,04 €



## CV-V SERİSİ VİTONLU HAT TİPİ ÇEK VALFLER

### OLEOCON HİDROLİK VİTONLU ÇEK VALF SERİSİ

ÜRÜN KODU	ÖLÇÜSÜ	ÇALIŞMA BASINCI (BAR)	FİYATI
CV-201V	1/4" BSP	450	12,21 €
CV-202V	3/8" BSP	450	13,32 €
CV-203V	1/2" BSP	400	13,88 €
CV-204V	3/4" BSP	380	27,75 €
CV-205V	1" BSP	350	48,85 €
CV-206V	1 1/4" BSP	350	67,71 €
CV-207V	1 1/2" BSP	280	81,03 €
CV-208V	2" BSP	260	113,22€



## PS 401 SERİSİ HİDROLİK BASINÇ EMNİYET VALFİ

### OLEOCON BASINÇ EMNİYET VALFİ

ÜRÜN KODU	ÖLÇÜSÜ	ÇALIŞMA BASINCI (BAR)	FİYATI
PS401	1/2" BASINÇ EMNİYET VALFİ		29,63 €



## TLV SERİSİ İKİZ KİLİTLEME VALFLERİ

### OLEOCON HİDROLİK İKİZ KİLİTLEME VALFLERİ

ÜRÜN KODU	ÖLÇÜSÜ	ÇALIŞMA BASINCI (BAR)	FİYATI
TLV-301	1/4 İKİZ KİLİTLEME VALFİ	380	12,00 €
TLV-302	3/8 İKİZ KİLİTLEME VALFİ	380	12,50 €
TLV-303	1/2 İKİZ KİLİTLEME VALFİ	360	25,00 €
TLV-S304	3/8 SOMUNLU İKİZ KİLİT VALFİ	380	11,85 €



## OHP SERİSİ HİDROLİK MANUEL EL POMPALARI

### OLEOCON MANUEL EL POMPASI - 25CC

ÜRÜN KODU	ÜRÜN CİNSİ	FİYATI €
OHP-501	TEK TESİRLİ EL POMPASI 25 CC	57,72 €
OHP-501T	TEK TESİRLİ TEK BASMALI EL POMPASI 25 CC	71,04 €
OHP-502	ÇİFT TESİRLİ EL POMPASI 25 CC	64,38 €



## OHP SERİSİ HİDROLİK MANUEL EL POMPALARI

### OLEOCON MANUEL EL POMPASI - 45CC

ÜRÜN KODU	ÜRÜN CİNSİ	FİYATI €
OHP-601	TEK TESİRLİ EL POMPASI 45 CC	69,93 €
OHP-602	ÇİFT TESİRLİ EL POMPASI 45 CC	76,59 €
ÜRÜN KODU	ÜRÜN CİNSİ	FİYATI
OHP-K	EL POMPASI TUTMA SAPI	9,44 €



## OLC-AT SERİSİ ALÜMİNYUM DEPOLAR

### HİDROLİK ALÜMİNYUM DEPOLAR

ÜRÜN KODU	ÜRÜN CİNSİ	FİYATI TL
OLC-AT-4001	ALÜMİNYUM DEPO 1LT.	503,50 TL
OLC-AT-4002	ALÜMİNYUM DEPO 2LT.	731,40 TL
OLC-AT-4003	ALÜMİNYUM DEPO 3LT.	832,10 TL
OLC-AT-4004	ALÜMİNYUM DEPO 4LT.	1.012,30 TL
OLC-AT-4005	ALÜMİNYUM DEPO 5LT.	1.208,40 TL
OLC-AT-4001-E	ALÜMİNYUM DEPO 1LT. ENJEKSİYONLU	371,00 TL

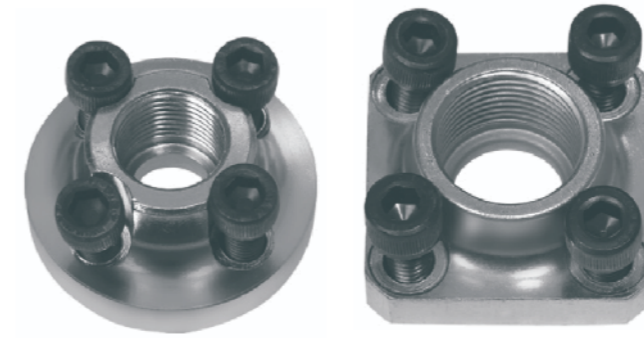

## DPA SERİSİ POMPA ADAPTÖRLERİ

### DÜZ POMPA ADAPTÖRLERİ

ÜRÜN KODU	ÜRÜN ADI	FİYATI TL
PA-801	3/8-30 DÜZ ADAPTÖR	56,18 TL
PA-802	3/8-35 DÜZ ADAPTÖR	61,48 TL
PA-803	1/2-40 DÜZ ADAPTÖR	71,00 TL
PA-804	3/4-48 DÜZ ADAPTÖR	87,00 TL
PA-805	3/4-51 DÜZ ADAPTÖR	103,00 TL
	1"-56 DÜZ ADAPTÖR	123,00 TL



## DPA SERİSİ POMPA ADAPTÖRLERİ

### DİRSEK POMPA ADAPTÖRLERİ

ÜRÜN KODU	ÜRÜN ADI	FİYATI €
DPA-901	3/8-30 DİRSEK ADAPTÖR	6,33 €
DPA-902	3/8-35 DİRSEK ADAPTÖR	6,33 €
DPA-903	1/2-30 DİRSEK ADAPTÖR	6,33 €
DPA-904	1/2-35 DİRSEK ADAPTÖR	6,33 €
DPA-905	1/2-40 DİRSEK ADAPTÖR	8,25 €
DPA-906	3/4-40 DİRSEK ADAPTÖR	8,25 €
DPA-907	3/4-48 DİRSEK ADAPTÖR	10,78 €
DPA-908	3/4-51 DİRSEK ADAPTÖR	12,10 €
DPA-099	1-51 DİRSEK ADAPTÖR	12,10 €
	1-48 DİRSEK ADAPTÖR	10,78 €



## MHC 2006 SERİSİ SAC KAPSÜL SIKMA APARATLARI

SAC KAPSÜL SIKMA APARATI		
ÜRÜN KODU	ÜRÜN ADI	BİRİM FİYATI
MHC 2006	6MM DEN 35MM E KADAR	300,00 €



## MHC 3000 SERİSİ SAC KAPSÜL SIKMA APARATI

SAC KAPSÜL SIKMA APARATI		
ÜRÜN KODU	ÜRÜN ADI	BİRİM FİYATI
MHC 3000	6MM DEN 35MM E KADAR	589,00 €



## PB 1001 SERİSİ BORU BÜKME APARATI

HİDROLİK BORU BÜKME APARATI		
ÜRÜN KODU	ÜRÜN ADI	BİRİM FİYATI
PB - 1001	MANUEL 6MM DEN ÇAP 20MM YE KADAR	100,00 €

## HİDROLİK SİLİNDİR ARKA KAPAK BASİT TİP

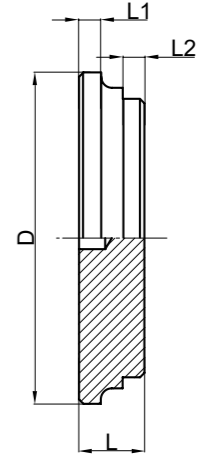

### Silindir Arka Kapak Basit Tip

ÜRÜN KODU	L	L1	L2	D	D1	BİRİM FİYATI
GDC-AK-32x40	15	5	5	40	32	€ 1,83
GDC-AK-35x45	15	5	5	45	35	€ 1,92
GDC-AK-40x50	15	5	5	50	40	€ 2,02
GDC-AK-45x55	15	5	5	55	45	€ 2,14
GDC-AK-50x60	15	5	5	60	50	€ 2,26
GDC-AK-50x65	15	5	5	65	50	€ 2,39
GDC-AK-55x65	15	5	5	65	55	€ 2,39
GDC-AK-60x70	15	5	5	70	60	€ 2,54
GDC-AK-60x80	15	5	5	80	60	€ 2,86
GDC-AK-63x75	15	5	5	75	63	€ 2,69
GDC-AK-65x80	15	5	5	80	65	€ 2,86
GDC-AK-70x85	15	5	5	85	70	€ 3,04
GDC-AK-75x90	15	5	5	90	75	€ 3,48
GDC-AK-80x95	15	5	5	95	80	€ 3,68
GDC-AK-80x100	15	5	5	100	80	€ 4,06
GDC-AK-85x100	20	9	5	100	85	€ 4,62
GDC-AK-90x105	20	9	5	105	90	€ 5,15
GDC-AK-90x110	20	9	5	110	90	€ 5,46
GDC-AK-100x115	20	9	5	115	100	€ 6,05
GDC-AK-100x120	20	9	5	120	100	€ 6,39
GDC-AK-110x130	20	9	5	130	110	€ 8,00
GDC-AK-115x130	20	9	5	130	115	€ 8,00
GDC-AK-120x140	20	9	5	140	120	€ 9,13
GDC-AK-125x145	20	9	5	145	125	€ 10,06
GDC-AK-125x150	20	9	5	150	125	€ 10,06
GDC-AK-130x150	20	9	5	150	130	€ 10,06
GDC-AK-140x160	20	9	5	160	140	€ 11,31
GDC-AK-150x170	20	9	5	170	150	€ 12,60
GDC-AK-160x190	25	9	5	190	160	€ 19,29
GDC-AK-170x190	25	9	5	190	170	€ 20,84
GDC-AK-180x210	25	9	5	210	180	€ 22,46
GDC-AK-200x245	30	9	5	245	200	€ 34,24
GDC-AK-220x270	30	9	8	270	220	€ 49,50
GDC-AK-230x280	30	9	8	280	230	€ 52,74
GDC-AK-250x300	30	9	8	300	250	€ 61,11

TEKNİK ÖZELLİKLER	MALZEME	W.No
	S355JR	1.0045
SAE 1030	1.0528	













**HİDROLİK SİLİNDİR PİSTON  
STD. 1**

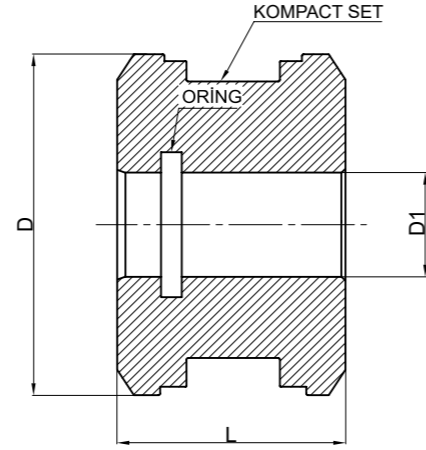

1040 / 1050 Çelik Piston Düz Tip

ÜRÜN KODU	KOMPACT SET	O-RING	D	D1	L	BİRİM FİYATI	KEÇE FİYATI
GDC-P 32x15	32x24x15.5x3.10	YOK	32	15	32	€ 3,65	€ 1,61
GDC-P 35x16	35x25x16.4x6,35	16x3	35	16	40	€ 3,78	€ 2,00
GDC-P 40x16	40x32x15.5x3,20	16x3	40	16	40	€ 4,00	€ 1,89
GDC-P 40x20	40x32x15.5x3,20	20x3	40	20	40	€ 3,49	€ 1,91
GDC-P 45x20	45x35x16.4x6,35	20x3	45	20	40	€ 3,99	€ 2,18
GDC-P 50x16	50x38x20.5x4,20	16x3	50	16	40	€ 4,27	€ 2,10
GDC-P 50x20	50x38x20.5x4,20	20x3	50	20	40	€ 4,27	€ 2,12
GDC-P 50x30	50x38x20.5x4,20	30x3	50	30	40	€ 4,27	€ 2,13
GDC-P 55x20	55x39x20.5x3,10	20x3	55	20	40	€ 4,58	€ 2,46
GDC-P 60x20	60x48x20.5x4,20	20x3	60	20	40	€ 4,92	€ 2,46
GDC-P 63x20	63x51x20.5x4,20	25x3	63	20	40	€ 5,29	€ 2,48
GDC-P 63x25	63x51x20.5x4,20	25x3	63	25	40	€ 5,29	€ 2,48
GDC-P 63x30	63x51x20.5x4,20	30x3	63	30	40	€ 5,29	€ 2,50
GDC-P 65x25	65x49x20.5x3,10	25x3	65	25	40	€ 5,29	€ 2,91
GDC-P 70x25	70x58x20.5x4,20	25x3	70	25	40	€ 5,95	€ 2,64
GDC-P 70x30	70x58x20.5x4,20	30x3	70	30	40	€ 5,95	€ 2,65
GDC-P 75x32	75x55x22.4x6,35	32x3	75	32	50	€ 7,11	€ 2,99
GDC-P 80x27	80x66x22.4x5,20	27x3	80	27	50	€ 7,73	€ 3,21
GDC-P 80x30	80x66x22.4x5,20	30x3	80	30	50	€ 7,73	€ 3,21

Keçeli ürünlerimizde ALP Marka keçeler kullanılmaktadır.

**HİDROLİK SİLİNDİR PİSTON  
STD. 1**

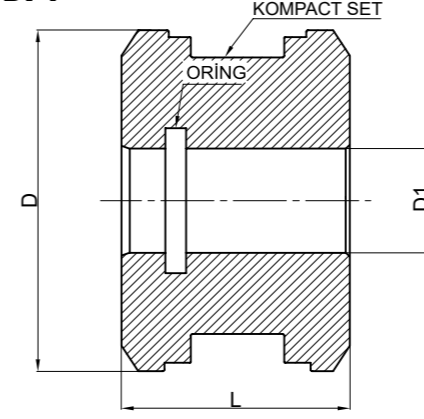

1040 / 1050 Çelik Piston Düz Tip

ÜRÜN KODU	KOMPACT SET	O-RING	D	D1	L	BİRİM FİYATI	KEÇE FİYATI
GDC-P 85x32	85x65x22.4x6,35	32x3	85	32	50	€ 8,33	€ 3,63
GDC-P 90x30	90x76x22.4x5,20	30x3	90	30	50	€ 8,96	€ 3,52
GDC-P 100x33	100x86x22.4x5,20	33x3	100	33	50	€ 11,78	€ 3,97
GDC-P 100x40	100x86x22.4x5,20	40x4	100	40	50	€ 11,78	€ 4,05
GDC-P 110x40	110x96x22.4x5,20	40x4	110	40	50	€ 13,69	€ 4,31
GDC-P 115x40	115x101x22.4x5,20	40x4	115	40	50	€ 14,59	€ 4,29
GDC-P 120x40	120x106x22.4x5,20	40x4	120	40	50	€ 15,52	€ 4,61
GDC-P 125x40	125x103x26.5x5,10	40x4	125	40	50	€ 16,50	€ 5,21
GDC-P 130x40	130x105x25.4x6,35	40x4	130	40	60	€ 20,53	€ 5,34
GDC-P 140x40	140x123x26.5x7,20	40x4	140	40	60	€ 24,59	€ 5,27
GDC-P 150x40	150x125x25.4x6,35/1	40x4	150	40	60	€ 27,32	€ 7,40
GDC-P 160x50	160x143x26.5x7,20	50x4	160	50	60	€ 32,49	€ 6,68
GDC-P 170x50	170x145x25.4x12,70	50x4	170	50	65	€ 38,51	€ 9,24
GDC-P 180x50	180x163x26.5x7,20	50x4	180	50	60	€ 39,71	€ 7,76
GDC-P 190x50	190x165x25.4x12,7	50x4	190	50	65	€ 47,42	€ 11,12
GDC-P 200x55	200x175x25.4x12,70/1	55x4	200	55	65	€ 52,02	€ 13,50
GDC-P 220x70	220x190x35.4x6,35/1	70x4	220	70	70	€ 65,43	€ 18,54
GDC-P 230x70	230x205x25.4x12,70	70x4	230	70	70	€ 71,90	€ 12,45
GDC-P 250x80	250x225x25.4x12,70	80x4	250	80	70	€ 84,79	€ 14,60

Keçeli ürünlerimizde ALP Marka keçeler kullanılmaktadır.



**HYT  
SERİSİ**

## YAĞ TANKI

ÜNİTE İÇİN YAĞ TANKLARI

**FORM**  
HYDRAULIC + PNEUMATIC

ÜRÜN KODU	ÜRÜN TANIMI	BOYUT	TANK	ÜST KAPAK	CONTA	SET
HYT-06	6 LT KAYNAKSIZ KARE TANK SET	220-290-150	22,86 \$	4,94 \$	3,05 \$	27,37 \$
HYT-08	8 LT KAYNAKSIZ KARE TANK SET	220-290-190	27,44 \$	4,94 \$	3,66 \$	32,84 \$
HYT-12	12 LT KAYNAKSIZ KARE TANK SET	260-350-180	29,94 \$	5,92 \$	3,32 \$	34,86 \$
HYT-15	15 LT KAYNAKSIZ KARE TANK SET	260-350-220	37,42 \$	5,92 \$	4,15 \$	43,80 \$
HYT-25	25 LT KAYNAKSIZ KARE TANK SET	330-440-230	45,15 \$	10,38 \$	4,86 \$	53,36 \$
HYT-30	30 LT KAYNAKSIZ KARE TANK SET	330-440-280	54,19 \$	10,38 \$	5,83 \$	64,03 \$
HYT-40	40 LT KAYNAKSIZ KARE TANK SET	380-510-270	61,68 \$	14,42 \$	6,53 \$	73,64 \$
HYT-50	50 LT KAYNAKSIZ KARE TANK SET	380-510-330	77,09 \$	14,42 \$	8,16 \$	92,05 \$
HYT-70	70 LT KAYNAKSIZ KARE TANK SET	450-610-330	93,41 \$	25,53 \$	10,78 \$	114,10 \$
HYT-90	90 LT KAYNAKSIZ KARE TANK SET	450-610-410	112,09 \$	25,93 \$	12,94 \$	136,93 \$
HYT-100	100 LT KAYNAKSIZ KARE TANK SET	500-680-370	122,81 \$	31,64 \$	11,43 \$	147,13 \$
HYT-120	120 LT KAYNAKSIZ KARE TANK SET	500-680-430	147,37 \$	31,64 \$	13,72 \$	176,55 \$
HYT-160	160 LT KAYNAKSIZ KARE TANK SET	570-780-430	167,39 \$	58,42 \$	17,55 \$	201,51 \$
HYT-200	200 LT KAYNAKSIZ KARE TANK SET	570-780-500	200,87 \$	61,09 \$	21,07 \$	245,05 \$
HYT-250	250 LT KAYNAKSIZ KARE TANK SET	660-900-500	226,59 \$	76,76 \$	23,07 \$	271,64 \$

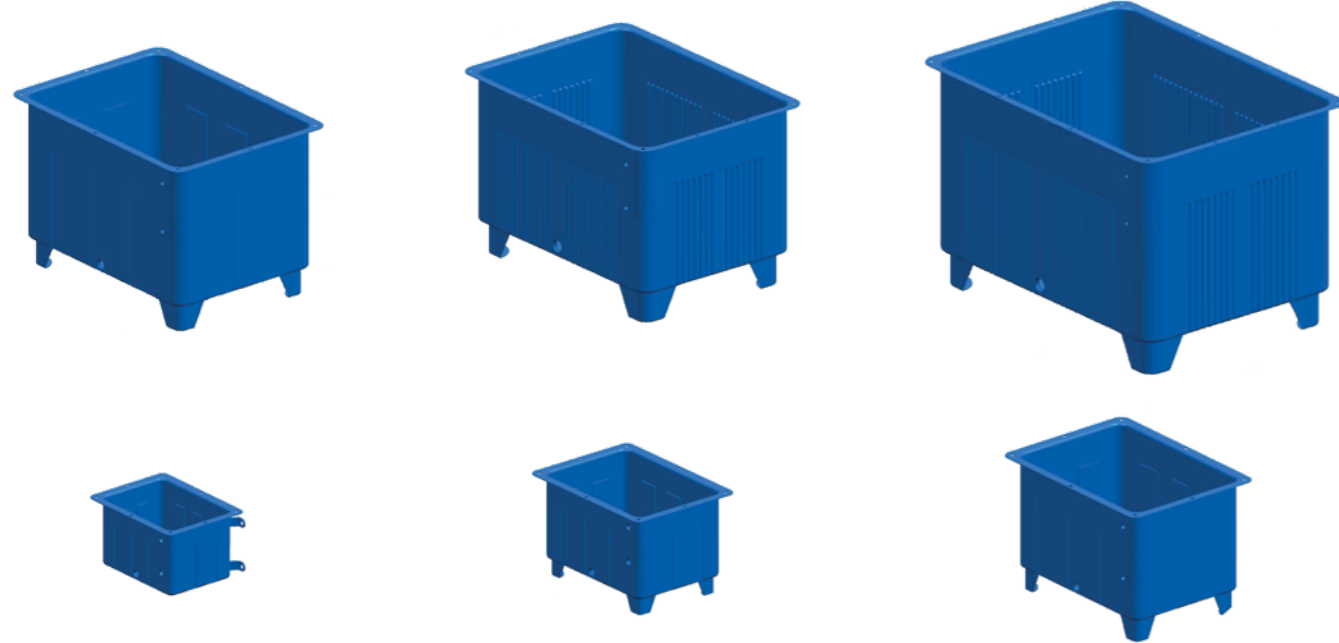

## DEPO KAPAĞI

ÜNİTE İÇİN DEPO KAPAKLARI

**DK  
SERİSİ**

ÜRÜN KODU	ÜRÜN ADI	BİRİM FİYATI
DK-402	Küçük Boy Depo Kapağı Vidalı Kromajlı	96,25 ₺
DK-403	Büyük Boy Depo Kapağı Vidalı Boyalı	123,75 ₺
DK-404	Büyük Boy Depo Kapağı Vidalı Kromajlı	134,75 ₺

## DERECELİ GÖSTERGE

ÜNİTE İÇİN DERECELİ  
SEVİYE GÖSTERGELERİ  
(ALÜMİNYUM)

**SG  
SERİSİ**



ÜRÜN KODU	ÜRÜN ADI	BİRİM FİYATI
SG-501	76mm Seviye Göstergesi Dereceli	134,75 ₺
SG-502	127mm Seviye Göstergesi Dereceli	140,25 ₺
SG-503	254mm Seviye Göstergesi Dereceli	238,15 ₺

## GÖSTERGELER

ÜNİTE İÇİN ALÜMİNYUM / POLİKARBON  
SEVİYE GÖSTERGE

**ASG  
/ PSG  
SERİSİ**

ÜRÜN KODU	ÜRÜN ADI	BİRİM FİYATI
ASG-601	1/4" Alüminyum Yağ Seviye Göstergesi	48,30 ₺
ASG-602	3/8" Alüminyum Yağ Seviye Göstergesi	37,95 ₺
ASG-603	1/2" Alüminyum Yağ Seviye Göstergesi	42,55 ₺
ASG-604	3/4" Alüminyum Yağ Seviye Göstergesi	49,45 ₺
ASG-605	1" Alüminyum Yağ Seviye Göstergesi	69,00 ₺
ASG-606	1"1/4" Alüminyum Yağ Seviye Göstergesi	216,20 ₺
ASG-607	1"1/2" Alüminyum Yağ Seviye Göstergesi	230,46 ₺
ÜRÜN KODU	ÜRÜN ADI	BİRİM FİYATI
PSG-701	3/8" Polikarbon Yağ Seviye Göstergesi	16,10 ₺
PSG-702	1/2" Polikarbon Yağ Seviye Göstergesi	21,85 ₺
PSG-703	3/4" Polikarbon Yağ Seviye Göstergesi	26,45 ₺
PSG-704	1" Polikarbon Yağ Seviye Göstergesi	34,50 ₺



## BAKIM KAPAĞI

ÜNİTE İÇİN BAKIM KAPAKLARI

**BK  
SERİSİ**

ÜRÜN KODU	ÜRÜN ADI	BİRİM FİYATI
BK-250	250 LİK BAKIM KAPAĞI CONTALI	482,30 ₺
BK-300	300 LÜK BAKIM KAPAĞI CONTALI	694,30 ₺
BK-350	350 LİK BAKIM KAPAĞI CONTALI	906,30 ₺



**OK  
SERİSİ**

## OK KAMPANA

### OK MİNİ KAMPANA SERİSİ

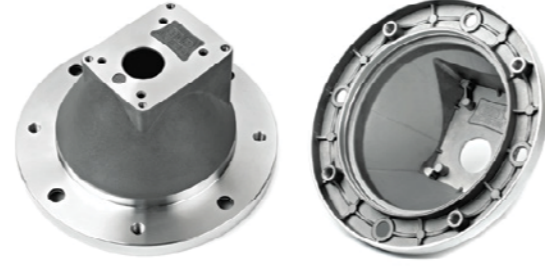

ÇAP	ELEKTRİK MOTORU (KW)	BİRİM FİYATI
OK-140	0,9-0,12-0,18 KW	292,56 ₺
OK-160	0,25-0,37 KW ENJEKSİYON	318,00 ₺
OK-200 Boy:90	0,55-0,75-1-1,1-1,5 KW ENJEKSİYON	SORUNUZ
OK-200 Boy:100	0,55-0,75-1-1,1-1,5 KW ENJEKSİYON	375,54 ₺
OK-250	2,2-3-3,7-4 KW ENJEKSİYON	464,28 ₺

**1K  
SERİSİ**

## 1K KAMPANA

### 1K KAMPANA(1P1 POMPA İÇİN)

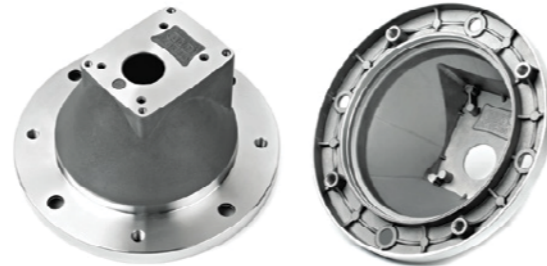

ÇAP	ELEKTRİK MOTORU (KW)	BİRİM FİYATI
1K- 160	0,25-0,37 KW ENJEKSİYON	318,00 ₺
1K- 200 Boy:90	0,55-0,75-1-1,1-1,5 KW ENJEKSİYON	SORUNUZ
1K- 200 Boy:100	0,55-0,75-1-1,1-1,5 KW ENJEKSİYON	375,24 ₺
1K - 250	2,2-3-3,7-4 KW ENJEKSİYON	664,28 ₺
1K-300	5,5-7,5-10 KW ENJEKSİYON	884,04 ₺
1K-350	11-15-18,5-22 KW	1.195,68 ₺

## 2K KAMPANA

### 2K KAMPANA SERİSİ (2P1 POMPA İÇİN)

**2K  
SERİSİ**

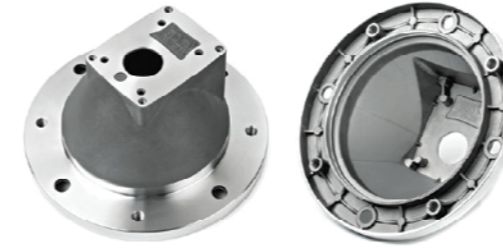

ÇAP	ELEKTRİK MOTORU (KW)	BİRİM FİYATI
2K - 200	0,55-0,75-1-1,1-1,5 KW	534,24 ₺
2K - 250	2,2-3-3,7-4 KW	610,56 ₺
2K - 300	5,5-7,5-10 KW Enjeksiyon	884,04 ₺
2K - 350	11-15-18,5-22 KW Enjeksiyon	1.195,68 ₺

## KAVİ ve KARE KAMPANA

### KAVİ VE KARE KAMPANA SERİSİ

**KAVİ  
SERİSİ**

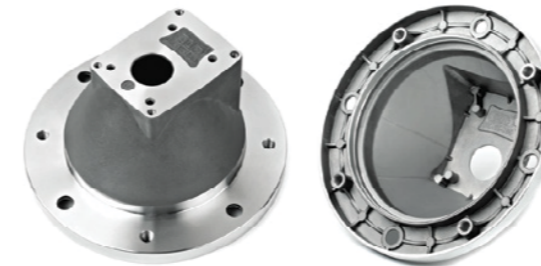

ÇAP	ELEKTRİK MOTORU (KW)	BİRİM FİYATI
KAVİ ve KARE-200	0,55-0,75-1-1,1-1,5 KW	661,44 ₺
KAVİ ve KARE-250	2,2-3-3,7-4 KW	820,44 ₺
KAVİ ve KARE-300	5,5-7,5-10 KW	1.100,00 ₺
KAVİ ve KARE-350	11-15-18,5-22 KW	1.526,50 ₺

**DA  
SERİSİ**

**DOLU KAPLİN**

**DOLU ELASTİK DİŞLİ KAPLİN**

ÜRÜN KODU	TAKIM FİYATI	YEDEK PLASTİK FİYATI	YEDEK DİŞLİ FİYATI
DA14 ÇELİK	7,91 €	1,65 €	3,29 €
DA 24	9,09 €	1,98 €	3,74 €
DA 28	12,87 €	2,50 €	5,46 €
DA 32	14,59 €	3,70 €	5,73 €
DA 38	18,59 €	4,14 €	6,76 €
DA 42	18,72 €	4,37 €	7,56 €
DA 48	22,59 €	5,57 €	8,96 €
DA 55	36,03 €	7,36 €	15,09 €
DA 60	56,45 €	10,64 €	23,29 €



**DA  
SERİSİ**

**İŞLENMİŞ KAPLİN**

**İŞLENMİŞ ELASTİK DİŞLİ KAPLİN**

ÜRÜN KODU	İŞLENMİŞ POMPA ÖLÇÜSÜ	ELEKTRİK MOTORU MİL ÖLÇÜSÜ	İŞLENMİŞ KAPLİN TAKIM FİYATI	İŞLENMİŞ YEDEK DİŞLİ FİYATI	İŞLENMİŞ YEDEK DİŞLİ 8 FREZELİ
DA-14 İŞLENMİŞ	OP1-1P1	14 MM	9,93 €	4,36 €	-
DA-24 İŞLENMİŞ	OP1-1P1	14-19-24 MM	11,14 €	4,82 €	-
DA-28 İŞLENMİŞ	OP1-1P1-2P1	14-19-24-28 MM	15,54 €	6,86 €	-
DA-32 İŞLENMİŞ	1P1-2P1	19-24-28-32 MM	17,05 €	7,03 €	11,80 €
DA-38 İŞLENMİŞ	1P1-2P1	19-24-28-32-38 MM	19,20 €	7,92 €	12,69 €
DA-42 İŞLENMİŞ	1P1-2P1	24-28-38-42 MM	20,96 €	8,73 €	13,50 €
DA-48 İŞLENMİŞ	1P1-2P1	32-38-42-48 MM	25,90 €	10,70 €	15,47 €
DA-55 İŞLENMİŞ	1P1-2P1	28-38-42-48-55 MM	41,51 €	17,98 €	22,75 €
DA-60 İŞLENMİŞ	1P1-2P1	42-48-55-60 MM	61,31 €	26,67 €	31,44 €



**EMİŞ FİLTRESİ**

**ÜNİTE İÇİN EMİŞ FİLTRELERİ**

**EMF  
SERİSİ**

ÜRÜN KODU	ÜRÜN ADI	ALUMİNYUM KAFALI FİYATI
EMF-302	15 LT. Emiş Filtresi 1"	122,58 TL
EMF-303	25 LT. Emiş Filtresi 1"	131,85 TL
EMF-304	45 LT. Emiş Filtresi 1"	149,76 TL
EMF-305	65 LT. Emiş Filtresi 1-1/2"	192,00 TL
EMF-306	90 LT. Emiş Filtresi 1-1/2"	220,00 TL
EMF-307	125 LT. Emiş Filtresi 1-1/2"	243,20 TL
EMF-309	180 LT. Emiş Filtresi 1-1/2"	282,88 TL
EMF-310	225 LT. Emiş Filtresi 2"	376,32 TL
EMF-311	300 LT. Emiş Filtresi 2"	428,80 TL
EMF-312	500 LT. Emiş Filtresi 2"	453,12 TL
EMF-313	750 LT. Emiş Filtresi 3"	632,32 TL
EMF-314	1400 LT. Emiş Filtresi 3"	1.034,24 TL



**KYZ  
SERİSİ**

**KELEPÇE**

**TAKVİYELİ  
GALVANİZLİ ÇELİK**



ÜRÜN KODU	SIKMA ARALIĞI (mm)	BİRİM FİYATI
KYZ/T-013015	13-15 MM TAKVİYELİ KELEPÇE	32,18 TL
KYZ/T-015017	15-17 MM TAKVİYELİ KELEPÇE	32,45 TL
KYZ/T-017019	17-19 MM TAKVİYELİ KELEPÇE	32,54 TL
KYZ/T-019021	19-21 MM TAKVİYELİ KELEPÇE	33,06 TL
KYZ/T-021023	21-23 MM TAKVİYELİ KELEPÇE	33,51 TL
KYZ/T-023025	23-25 MM TAKVİYELİ KELEPÇE	34,05 TL
KYZ/T-025027	25-27 MM TAKVİYELİ KELEPÇE	34,14 TL
KYZ/T-027029	27-29 MM TAKVİYELİ KELEPÇE	34,49 TL
KYZ/T-029031	29-31 MM TAKVİYELİ KELEPÇE	34,58 TL
KYZ/T-031033	31-33 MM TAKVİYELİ KELEPÇE	35,09 TL
KYZ/T-034036	34-36 MM TAKVİYELİ KELEPÇE	37,56 TL
KYZ/T-037040	37-40 MM TAKVİYELİ KELEPÇE	37,96 TL
KYZ/T-041043	41-43 MM TAKVİYELİ KELEPÇE	38,52 TL
KYZ/T-044046	44-46 MM TAKVİYELİ KELEPÇE	38,74 TL
KYZ/T-047051	47-51 MM TAKVİYELİ KELEPÇE	39,12 TL
KYZ/T-049053	49-53 MM TAKVİYELİ KELEPÇE	39,57 TL
KYZ/T-052055	52-55 MM TAKVİYELİ KELEPÇE	39,91 TL
KYZ/T-056061	56-61 MM TAKVİYELİ KELEPÇE	40,24 TL
KYZ/T-059065	59-65 MM TAKVİYELİ KELEPÇE	40,38 TL
KYZ/T-062067	62-67 MM TAKVİYELİ KELEPÇE	46,87 TL
KYZ/T-065072	65-71 MM TAKVİYELİ KELEPÇE	47,23 TL
KYZ/T-068074	68-74 MM TAKVİYELİ KELEPÇE	47,29 TL
KYZ/T-072078	72-78 MM TAKVİYELİ KELEPÇE	47,79 TL
KYZ/T-075083	75-83 MM TAKVİYELİ KELEPÇE	48,00 TL
KYZ/T-084091	84-91 MM TAKVİYELİ KELEPÇE	49,21 TL
KYZ/T-092102	92-102 MM TAKVİYELİ KELEPÇE	49,92 TL
KYZ/T-100108	100-108 MM TAKVİYELİ KELEPÇE	51,55 TL
KYZ/T-103110	103-110 MM TAKVİYELİ KELEPÇE	52,44 TL
KYZ/T-110120	110-120 MM TAKVİYELİ KELEPÇE	53,68 TL
KYZ/T-112121	112-121 MM TAKVİYELİ KELEPÇE	54,16 TL
KYZ/T-121131	121-131 MM TAKVİYELİ KELEPÇE	54,30 TL
KYZ/T-135145	135-145 MM TAKVİYELİ KELEPÇE	55,73 TL
KYZ/T-145155	145-155 MM TAKVİYELİ KELEPÇE	56,43 TL
KYZ/T-155165	155-165 MM TAKVİYELİ KELEPÇE	56,81 TL
KYZ/T-165175	165-175 MM TAKVİYELİ KELEPÇE	58,16 TL
KYZ/T-174187	174-187 MM TAKVİYELİ KELEPÇE	59,20 TL

Materyal: Galvanize Çelik 8.8  
Korozyon Direnci : Min. 72 saat





**AĞIR TİP  
HORTUM  
REKORLARI**



**DiŞİ  
HORTUM  
REKORU**



KODU	ÖLÇÜ	FİYATI
AHR 001	1/8x6	22,50 TL
AHR 002	1/8x8	22,50 TL
AHR 003	1/8x10	22,50 TL
AHR 004	1/8x12	22,50 TL
AHR 005	1/4x6	28,50 TL
AHR 006	1/4x8	28,50 TL
AHR 007	1/4x10	28,50 TL
AHR 008	1/4x12	28,50 TL
AHR 009	3/8x6	30,00 TL
AHR 010	3/8x8	30,00 TL
AHR 011	3/8x10	30,00 TL
AHR 012	3/8x12	32,00 TL
AHR 013	3/8x16	33,00 TL
AHR 014	1/2x6	35,00 TL
AHR 015	1/2x8	35,00 TL
AHR 016	1/2x10	35,00 TL
AHR 017	1/2x13	44,00 TL
AHR 018	1/2x16	44,00 TL
AHR 019	1/2x20	44,00 TL
AHR 020	3/4x8	69,00 TL
AHR 021	3/4x10	69,00 TL
AHR 022	3/4x13	69,00 TL
AHR 023	3/4x16	75,00 TL
AHR 024	3/4x20	75,00 TL
AHR 025	3/4x27	105,00 TL
AHR 026	1x20	125,00 TL
AHR 027	1x27	122,00 TL
AHR 028	1x33	158,00 TL
AHR 029	11/4x33	259,00 TL
AHR 030	11/4x40	268,00 TL
AHR 031	11/2x40	280,00 TL
AHR 032	11/2x50	350,00 TL
AHR 033	2x50	405,00 TL

KOD	ÖLÇÜ	FİYAT
DHR 01	1/8x6 mm	45,00 TL
DHR 02	1/8x8 mm	45,00 TL
DHR 03	1/8x10 mm	45,00 TL
DHR 04	1/8x12 mm	45,00 TL
DHR 05	1/4x6 mm	49,00 TL
DHR 06	1/4x8 mm	49,00 TL
DHR 07	1/4x10 mm	49,00 TL
DHR 08	1/4x12 mm	49,00 TL
DHR 09	3/8x6 mm	60,00 TL
DHR 10	3/8x8 mm	60,00 TL
DHR 11	3/8x10 mm	60,00 TL
DHR 12	3/8x12 mm	65,00 TL
DHR 13	1/2x6 mm	68,00 TL
DHR 14	1/2x8 mm	68,00 TL
DHR 15	1/2x10 mm	68,00 TL
DHR 16	1/2x12 mm	68,00 TL
DHR 17	1/2x16 mm	68,00 TL
DHR 18	1/2x20 mm	68,00 TL
DHR 19	3/4x6 mm	100,00 TL
DHR 20	3/4x8 mm	100,00 TL
DHR 21	3/4x10 mm	100,00 TL
DHR 22	3/4x12 mm	100,00 TL
DHR 23	3/4x16 mm	115,00 TL
DHR 24	3/4x20 mm	115,00 TL

**HAFİF TİP  
HORTUM  
REKORLARI**



KODU	ÖLÇÜ	FİYATI
HR 001	3/4x20	60,00 TL
HR 002	1x27	78,00 TL
HR 003	11/4x33	120,00 TL
HR 004	11/2x40	151,00 TL
HR 005	2x50	260,00 TL
HR 006	21/2	485,00 TL
HR 007	3	685,00 TL
HR 008	4	1.050,00 TL

**HORTUM  
TE**



KOD	ÖLÇÜ / CİNSİ	FİYAT
HT 01	6 mm HORTUM TE	52,50 TL
HT 02	8 mm HORTUM TE	62,00 TL
HT 03	10 mm HORTUM TE	74,00 TL
HT 04	13 mm HORTUM TE	102,00 TL
HT 05	16 mm HORTUM TE	167,00 TL
HT 06	20 mm HORTUM TE	245,00 TL
HT 07	27 mm HORTUM TE	464,00 TL
HT 08	33 mm HORTUM TE	662,00 TL
HT 09	40 mm HORTUM TE	772,00 TL

**HORTUM  
EKİ**



KOD	ÖLÇÜ / CİNSİ	FİYAT
HE 01	6 mm HORTUM EKİ	26,00 TL
HE 02	8 mm HORTUM EKİ	30,00 TL
HE 03	10 mm HORTUM EKİ	37,00 TL
HE 04	13 mm HORTUM EKİ	67,00 TL
HE 05	16 mm HORTUM EKİ	93,00 TL
HE 06	20 mm HORTUM EKİ	137,00 TL
HE 07	27 mm HORTUM EKİ	250,00 TL
HE 08	33 mm HORTUM EKİ	447,00 TL
HE 09	40 mm HORTUM EKİ	534,00 TL

TE



KOD	ÖLÇÜ / CİNSİ	FİYAT
T 01	1/8 TE	53,00 TL
T 02	1/4 TE	56,00 TL
T 03	3/8 TE	60,00 TL
T 04	1/2 TE	78,00 TL
T 05	3/4 TE	110,00 TL
T 06	1 TE	185,00 TL
T 07	1 1/4 TE	543,00 TL
T 08	1 1/2 TE	597,00 TL
T 09	2 TE	860,00 TL
T 10	2 1/2 TE	2.650,00 TL

DİRSEK



KOD	ÖLÇÜ / CİNSİ	FİYAT
D 01	1/8 DİRSEK	46,00 TL
D 02	1/4 DİRSEK	52,50 TL
D 03	3/8 DİRSEK	56,00 TL
D 04	1/2 DİRSEK	77,00 TL
D 05	3/4 DİRSEK	105,00 TL
D 06	1 DİRSEK	180,00 TL
D 07	1 1/4 DİRSEK	550,00 TL
D 08	1 1/2 DİRSEK	605,00 TL
D 09	2 DİRSEK	810,00 TL
D 10	2 1/2 DİRSEK	2.700,00 TL

KUYRUKLU  
DİRSEK



KOD	ÖLÇÜ / CİNSİ	FİYAT
KD 01	1/8 KUYRUKLU DİRSEK	46,00 TL
KD 02	1/4 KUYRUKLU DİRSEK	52,50 TL
KD 03	3/8 KUYRUKLU DİRSEK	56,00 TL
KD 04	1/2 KUYRUKLU DİRSEK	77,00 TL
KD 05	3/4 KUYRUKLU DİRSEK	110,00 TL
KD 06	1 KUYRUKLU DİRSEK	185,00 TL
KD 07	1 1/4 KUYRUKLU DİRSEK	555,00 TL
KD 08	1 1/2 KUYRUKLU DİRSEK	625,00 TL
KD 09	2 KUYRUKLU DİRSEK	885,00 TL
KD 10	2 1/2 KUYRUKLU DİRSEK	2.900,00 TL

MAŞON



KOD	ÖLÇÜ / CİNSİ	FİYAT
M 01	1/8 MAŞON	17,50 TL
M 02	1/4 MAŞON	24,50 TL
M 03	3/8 MAŞON	30,00 TL
M 04	1/2 MAŞON	45,50 TL
M 05	3/4 MAŞON	65,00 TL
M 06	1 MAŞON	89,60 TL
M 07	1 1/4 MAŞON	203,00 TL
M 08	1 1/2 MAŞON	240,00 TL
M 09	2 MAŞON	333,00 TL
M 10	2 1/2 MAŞON	1.110,00 TL

KÖRTAPA



KOD	ÖLÇÜ / CİNSİ	FİYAT
KT 01	1/8 KÖR TAPA	17,00 TL
KT 02	1/4 KÖR TAPA	18,50 TL
KT 03	3/8 KÖR TAPA	24,50 TL
KT 04	1/2 KÖR TAPA	30,00 TL
KT 05	3/4 KÖR TAPA	44,00 TL
KT 06	1 KÖR TAPA	67,00 TL
KT 07	1 1/4 KÖR TAPA	149,00 TL
KT 08	1 1/2 KÖR TAPA	184,00 TL
KT 09	2 KÖR TAPA	240,00 TL
KT 10	2 1/2 KÖR TAPA	846,00 TL

LÜLE



KOD	ÖLÇÜ / CİNSİ	FİYAT
L 01	1/4x1/8 LÜLE	28,00 TL
L 02	3/8x1/8 LÜLE	33,50 TL
L 03	3/8x1/4 LÜLE	33,50 TL
L 04	1/2x1/8 LÜLE	40,00 TL
L 05	1/2x1/4 LÜLE	37,00 TL
L 06	1/2x3/8 LÜLE	40,00 TL
L 07	3/4x1/4 LÜLE	58,00 TL
L 08	3/4x3/8 LÜLE	58,00 TL
L 09	3/4x1/2 LÜLE	58,00 TL
L 10	1x1/2 LÜLE	90,00 TL
L 11	1x3/4 LÜLE	90,00 TL
L 12	1 1/4x3/4 LÜLE	185,00 TL

Dişi  
KÖRTAPA



KOD	ÖLÇÜ / CİNSİ	FİYAT
DKT 01	1/8 Dişi TAPA	21,00 TL
DKT 02	1/4 Dişi TAPA	25,00 TL
DKT 03	3/8 Dişi TAPA	28,00 TL
DKT 04	1/2 Dişi TAPA	30,00 TL
DKT 05	3/4 Dişi TAPA	42,00 TL
DKT 06	1 Dişi TAPA	65,00 TL
DKT 07	1 1/4 Dişi TAPA	149,00 TL
DKT 08	1 1/2 Dişi TAPA	277,00 TL
DKT 09	2 Dişi TAPA	426,00 TL

ORANTILI  
NİPEL



KOD	ÖLÇÜ / CİNSİ	FİYATI
ON 01	1/4x1/8 ORANTILI NİPEL	24,50 TL
ON 02	3/8x1/8 ORANTILI NİPEL	30,00 TL
ON 03	3/8x1/4 ORANTILI NİPEL	30,00 TL
ON 04	1/2x1/8 ORANTILI NİPEL	32,00 TL
ON 05	1/2x1/4 ORANTILI NİPEL	31,00 TL
ON 06	1/2x3/8 ORANTILI NİPEL	31,00 TL
ON 07	3/4x1/4 ORANTILI NİPEL	51,00 TL
ON 08	3/4x3/8 ORANTILI NİPEL	51,00 TL
ON 09	3/4x1/2 ORANTILI NİPEL	47,00 TL
ON 10	1x1/2 ORANTILI NİPEL	68,00 TL
ON 11	1x3/4 ORANTILI NİPEL	68,00 TL
ON 12	1 1/4x1 ORT. NİP.	167,00 TL
ON 13	1 1/2x1 ORANTILI NİPEL	317,00 TL
ON 14	1 1/2x1 1/4 ORANTILI NİPEL	317,00 TL
ON 15	2x1 ORANTILI NİPEL	387,00 TL
ON 16	2x1 1/4 ORANTILI NİPEL	387,00 TL
ON 17	2x1 1/2 ORANTILI NİPEL	387,00 TL

**REDÜKSİYON  
GRUBU**



KODU	ÖLÇÜ	FİYATI
R 001	1/4x1/8	18,50 TL
R 002	3/8x1/8	21,50 TL
R 003	3/8x1/4	21,50 TL
R 004	1/2x1/8	30,00 TL
R 005	1/2x1/4	29,00 TL
R 006	1/2x3/8	29,00 TL
R 007	3/4x1/8	49,00 TL
R 008	3/4x1/4	48,00 TL
R 009	3/4x3/8	48,00 TL
R 010	3/4x1/2	43,00 TL
R 011	1x1/4	73,50 TL
R 012	1x3/8	73,50 TL
R 013	1x1/2	67,00 TL
R 014	1x3/4	67,00 TL
R 015	1 1/4x1/2	130,00 TL
R 016	1 1/4x3/4	130,00 TL
R 017	1 1/4x1	120,00 TL
R 018	1 1/2x1/2	221,00 TL
R 019	1 1/2x3/4	221,00 TL
R 020	1 1/2x1	210,00 TL
R 021	1 1/2x1 1/4	210,00 TL
R 022	2x1	330,00 TL
R 023	2x1 1/4	330,00 TL
R 024	2x1 1/2	330,00 TL
R 025	2 1/2x1	770,00 TL
R 026	2 1/2x1 1/4	770,00 TL
R 027	2 1/2x1 1/2	770,00 TL
R 028	2 1/2x2	770,00 TL

**NİPEL  
GRUBU**



KODU	CİNSİ	FİYATI
N 001	1/8 NİPEL	18,50 TL
N 002	1/4 NİPEL	22,50 TL
N 003	3/8 NİPEL	27,50 TL
N 004	1/2 NİPEL	30,00 TL
N 005	3/4 NİPEL	44,00 TL
N 006	1 NİPEL	66,50 TL
N 007	1 1/4 NİPEL	130,00 TL
N 008	1 1/2 NİPEL	158,00 TL
N 009	2 NİPEL	240,00 TL
N 010	2 1/2 NİPEL	815,00 TL
N 011	3 NİPEL	1.600,00 TL

**DÖRTYOL  
KRUVA**



KOD	ÖLÇÜ / CİNSİ	FİYAT
DK 01	1/8 DÖRT KRUVA	110,00 TL
DK 02	1/4 DÖRT KRUVA	114,00 TL
DK 03	3/8 DÖRT KRUVA	120,00 TL
DK 04	1/2 DÖRT KRUVA	149,00 TL
DK 05	3/4 DÖRT KRUVA	277,00 TL
DK 06	1 DÖRT KRUVA	450,00 TL

**ERKEK  
OTOMATİK  
REKOR**



KOD	ÖLÇÜ	FİYAT
EOR 01	1/4	95,00 TL
EOR 02	3/8	95,00 TL
EOR 03	1/2	95,00 TL

**DİŞİ  
OTOMATİK  
REKOR**



KOD	ÖLÇÜ	FİYAT
DOR 01	1/4	95,00 TL
DOR 02	3/8	95,00 TL
DOR 03	1/2	95,00 TL

**SABİT  
OTOMATİK  
REKOR**



KOD	ÖLÇÜ	FİYAT
SOR 01	6 mm	100,00 TL
SOR 02	8 mm	100,00 TL
SOR 03	10 mm	100,00 TL
SOR 04	12 mm	100,00 TL

**ERKEK JAK  
UCU**



KOD	ÖLÇÜ	FİYAT
EJU 01	1/4	37,00 TL
EJU 02	3/8	47,00 TL
EJU 03	1/2	57,00 TL

**DİŞİ JAK  
UCU**



KOD	ÖLÇÜ	FİYAT
DJU 01	1/4	45,00 TL
DJU 02	3/8	50,00 TL
DJU 03	1/2	60,00 TL

**JAK UCU**



KOD	ÖLÇÜ	FİYAT
JU 01	6 mm	28,00 TL
JU 02	8 mm	28,00 TL
JU 03	10 mm	28,00 TL
JU 04	12 mm	30,00 TL

### SİNTİNE



### POMPA REKORLARI



KOD	ÖLÇÜ / CİNSİ	FİYAT
S 01	1/2 SİNTİNE	228,00 TL
S 02	3/4 SİNTİNE	288,00 TL
S 03	1 SİNTİNE	406,00 TL
S 04	1 1/4 SİNTİNE	644,00 TL
S 05	1 1/2 SİNTİNE	800,00 TL
S 06	2 SİNTİNE	1.190,00 TL

KOD	ÖLÇÜ / CİNSİ	FİYAT
PR 01	1x1/2 POMPA REKORU TAKIMI	300,00 TL
PR 02	1 1/4x3/4 POMPA REKORU TAKIMI	330,00 TL
PR 03	1 1/2x1 POMPA REKORU TAKIMI	420,00 TL
PR 04	2x1 1/4 POMPA REKORU TAKIMI	700,00 TL
PR 05	2 1/2x1 1/2 POMPA REKORU TAKIMI	1.350,00 TL
PR 06	2 1/2x2 POMPA REKORU TAKIMI	3.500,00 TL

### KONİK REKOR



### DEPO REKORU



KOD	ÖLÇÜ / CİNSİ	FİYAT
KR 01	1/8 KONİK REKOR	167,00 TL
KR 02	1/4 KONİK REKOR	167,00 TL
KR 03	3/8 KONİK REKOR	195,00 TL
KR 04	1/2 KONİK REKOR	221,00 TL
KR 05	3/4 KONİK REKOR	277,00 TL
KR 06	1 KONİK REKOR	350,00 TL
KR 07	1 1/4 KONİK REKOR	610,00 TL
KR 08	1 1/2 KONİK REKOR	760,00 TL
KR 09	2 KONİK REKOR	1.105,00 TL
KR 10	2 1/2 KONİK REKOR	3.700,00 TL

KOD	ÖLÇÜ / CİNSİ	FİYAT
DBR 01	1/2 DEPO REKOR	90,00 TL
DBR 02	3/4 DEPO REKOR	120,00 TL
DBR 03	1 DEPO REKOR	180,00 TL
DBR 04	1 1/4 DEPO REKOR	280,00 TL
DBR 05	1 1/2 DEPO REKOR	370,00 TL
DBR 06	2 DEPO REKOR	550,00 TL

### MİNİ KÜRESEL VANA ERKEK DİŞİ



KOD	ÖLÇÜ	FİYAT
MKV 01	1/8	85,00 TL
MKV 02	1/4	85,00 TL
MKV 03	3/8	88,00 TL
MKV 04	1/2	95,00 TL
MKV 05	3/4	165,00 TL

### MİNİ KÜRESEL VANA DİŞİ

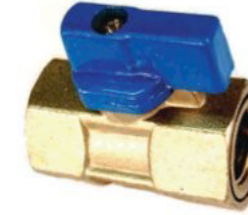

KOD	ÖLÇÜ	FİYAT
MKVD 01	1/8	90,00 TL
MKVD 02	1/4	90,00 TL
MKVD 03	3/8	100,00 TL
MKVD 04	1/2	115,00 TL
MKVD 05	3/4	180,00 TL

# KULLANDIĞIMIZ BÜTÜN ÜRÜNLER SERTİFİKALIDIR

**DNV**  
**DET NORSKE VERITAS**  
TYPE APPROVAL CERTIFICATE

CERTIFICATE NO. P-13693

This is to certify that the  
Flexible Hoses of Non-Metallic Material with Permanently Fitted Couplings  
with type designation(s)  
**AVENGER T1A/TKA, SURVIVOR RGP1, DIABAND T1D/TKD, ADVANTAGE DFI, ADVANTAGE T1E, T1F** are  
approved.

Manufactured by  
**RYCO Hydraulics Pty. Ltd.**  
FOOTSCRAY VICTORIA, Australia

It is found to comply with  
Det Norske Veritas' Rules for Classification of Ships  
Det Norske Veritas' Standards for Certification 2.9 No. 5-911.20

May be used for: Water based hydraulics, pneumatic systems (see cert), fresh water, sanitary, hydraulic oil, fuel oil and other oil systems.

Temperature range: -40°C to 150°C (see cert)  
Max. working pressure: 65 bar to 226 bar (dep. on size and type, see cert)  
Size: D16 - D260, 1" - 2" (see cert)

Held, 2014-02-07  
for Det Norske Veritas AS

This Certificate is valid until  
2015-02-01

DNV local office:  
Melbourne

DNV Signature  
Surveyor

**Lloyd's Register**

**Type Approval Certificate Extension**

This is to certify that Certificate No. 03/00096 for the undomated products is extended and renumbered as shown.

This certificate is issued to:

**PRODUCER** RYCO Hydraulics  
**PLACE OF PRODUCTION** 19 Whitshall Street, Footscray, Victoria 3011 Australia  
**DESCRIPTION** Flexible Hoses of Non-Metallic Material with Permanently Fitted Couplings, Designations: Avenger T1A, Diaband T1D, Survivor RGP1, Avenger T3KA, Diaband T3KD  
**TYPE** SAR 100R1  
**APPLICATION** For use on ships and offshore installations classed with Lloyd's Register, as short lengths in systems of fresh and seawater, compressed air, water based hydraulics, hydraulic oil, fuel and lubricating oil.  
**DESIGN CODE STANDARD** Part 5, Chapter 13 of Lloyd's Register's Rules and Regulations for the Classification of Ships (July 2009)  
Part 3, Chapter 10 of Lloyd's Register's Rules and Regulations for the Classification of Mobile Offshore Units (September 1996 plus Notices Nos. 1, 2, 3, 4, 5, 6 as applicable)  
Fire Resistant Testing according to ISO 1546/15541  
**RATINGS** Sizes: DN 5 to DN 51  
Maximum Working Pressure: 40 to 250 bar (see below)  
Service Temperature: -40°C to 150°C (see below)  
Coupling Material: Carbon Steel ASME SA312, SA314, Electroplated Fe/Zn 2: acc. to AS1789

Certificate No. 03/3800 (E1)  
Issue Date: 1 October 2008  
Expiry Date: 30 September 2013  
Sheet: 1 of 4

N. Nagamine  
Yokohama Design Support Office  
Lloyd's Register

**Type Approval Certificate** **Germanischer Lloyd**

This is to certify that the undomated product(s) has/have been tested in accordance with the relevant requirements of the G.L. Type Approval System.

Certificate No. 54 965 - 07 981  
Company: RYCO Hydraulics Pty. Ltd.  
19 Whitshall Street  
Footscray, VIC 3011, AUSTRALIA

Product Description: High pressure hoses - Flame resistant  
Type: Avenger T1A, Diaband T1D, Survivor RGP1

Environmental Category: None  
Technical Data / Range of Application: None design: Synthetic rubber tube, one steel wire braid, synthetic rubber cover acc. to EN 853 - 10N, SAE 100R5AT.  
Hose Type: T1A T1D RGP1  
Size range (DN): 5 to 26 6 to 32 6 to 26  
Pressure range (bar): 225 to 65 225 to 90  
Pressure/Temp.: T25, T20 Series Non-Flame  
Temperature range: -45 [°C] to 150 [°C]

RANGE OF APPLICATION  
The above mentioned hose types are type approved for the use in: Fuel oil, Lubricating oil, Hydraulic oil, Water, Seawater, Freshwater cooling, Sea water cooling, Compressed air and Ancillary piping systems.  
The selection of the hoses for the corresponding application is to be in accordance with the instructions of the hose manufacturer.

Test Standard: Regulations for the Performance of Type Tests, Part 6 Test Requirements for Mechanical Components and Equipment, T398, EN 853:1995  
Documents: \* Test reports of product tests according to EN 853:1995, Fire test reports according to ISO 1546/15541-1:2004, Burst test reports on hose assemblies - RYCO hydraulics catalogue RYCO-PRODUKTAUS

Remarks: Refer to page 2

Valid until: 2015-12-31  
Page: 1 of 2  
File No.: 6.0.01  
Hamburg, 2008-11-28

Germanischer Lloyd  
The certificate is based on the test results for the Performance of Type Approval, Part 1, Procedure.

Certificate Number: 06-001-0000-050A1

**Confirmation of Product Type Approval 16SEP2009**

Please refer to the "Service Restrictions" section below to determine if this Certificate is required for the product. This is to certify that, pursuant to the Rules of the American Bureau of Shipping (ABS), the manufacturer of the above product has had a representative of this Bureau, duly authorized, examine the product and the manufacturing process and has issued a Certificate of Approval (COA) for the product. The COA is a statement of the Bureau's approval of the product and is subject to the terms and conditions of the Rules of the American Bureau of Shipping (ABS) and the Rules of the American Bureau of Shipping (ABS) for the Classification of Ships (July 2009) and the Rules of the American Bureau of Shipping (ABS) for the Classification of Mobile Offshore Units (September 1996 plus Notices Nos. 1, 2, 3, 4, 5, 6 as applicable).

And a Product Design Assessment (PDA) was conducted in accordance with the Rules of the American Bureau of Shipping (ABS) and the Rules of the American Bureau of Shipping (ABS) for the Classification of Ships (July 2009) and the Rules of the American Bureau of Shipping (ABS) for the Classification of Mobile Offshore Units (September 1996 plus Notices Nos. 1, 2, 3, 4, 5, 6 as applicable).

The above certifies the product to be used in accordance with the Rules of the American Bureau of Shipping (ABS) and the Rules of the American Bureau of Shipping (ABS) for the Classification of Ships (July 2009) and the Rules of the American Bureau of Shipping (ABS) for the Classification of Mobile Offshore Units (September 1996 plus Notices Nos. 1, 2, 3, 4, 5, 6 as applicable).

ABS issues no representation regarding Type Approval of the Product for use on vessels, MOU's or facilities unless the use of the ABS Rules is required for the operation.

Due to the complexity of specifications used in the product, ABS has evaluated for Type Approval, it is part of our contract that neither the product is an ABS Rule or ABS Rule, nor does the user have responsibility for compliance with the ABS Rules.

**RYCO HYDRAULICS PTY LTD**  
Model Name(s): Avenger T1A Diaband AS1D, Diaband T1D Survivor RGP1  
Manufacturer: RYCO HYDRAULICS PTY LTD  
19 WHITSHALL STREET  
FOOTSCRAY  
Australia

Intended Service: For use on ships and offshore installations classed with American Bureau of Shipping, all applications for freshwater, seawater, water based hydraulics, and compressed air systems. For Avenger T1A also include hydraulic oil systems.

Designation: Flexible hoses of non-metallic material with permanently fitted couplings.

Range: Normal Size: 1/2 inch to 2 inch (see Service Restrictions/Maximum Working Pressure: 40 to 250 bar (see Service Restrictions/Service Temperature: 40 deg. F to 300 deg. F (see Service Restrictions/ Coupling Material: Carbon Steel ASME SA312, SA314, Electroplated Fe/Zn 2: acc. to AS1789)

Service Restrictions: Initial Certification is required for the product in accordance with the Rules of the American Bureau of Shipping (ABS) and the Rules of the American Bureau of Shipping (ABS) for the Classification of Ships (July 2009) and the Rules of the American Bureau of Shipping (ABS) for the Classification of Mobile Offshore Units (September 1996 plus Notices Nos. 1, 2, 3, 4, 5, 6 as applicable). The manufacturer of the product is responsible for the installation and operation of the product in accordance with the Rules of the American Bureau of Shipping (ABS) and the Rules of the American Bureau of Shipping (ABS) for the Classification of Ships (July 2009) and the Rules of the American Bureau of Shipping (ABS) for the Classification of Mobile Offshore Units (September 1996 plus Notices Nos. 1, 2, 3, 4, 5, 6 as applicable). The manufacturer of the product is responsible for the installation and operation of the product in accordance with the Rules of the American Bureau of Shipping (ABS) and the Rules of the American Bureau of Shipping (ABS) for the Classification of Ships (July 2009) and the Rules of the American Bureau of Shipping (ABS) for the Classification of Mobile Offshore Units (September 1996 plus Notices Nos. 1, 2, 3, 4, 5, 6 as applicable).

Comments: This certificate is valid until 16 SEP 2009. The user of the product is responsible for compliance with the Rules of the American Bureau of Shipping (ABS) and the Rules of the American Bureau of Shipping (ABS) for the Classification of Ships (July 2009) and the Rules of the American Bureau of Shipping (ABS) for the Classification of Mobile Offshore Units (September 1996 plus Notices Nos. 1, 2, 3, 4, 5, 6 as applicable).

Notes: Documentation: This certificate is valid until 16 SEP 2009. The user of the product is responsible for compliance with the Rules of the American Bureau of Shipping (ABS) and the Rules of the American Bureau of Shipping (ABS) for the Classification of Ships (July 2009) and the Rules of the American Bureau of Shipping (ABS) for the Classification of Mobile Offshore Units (September 1996 plus Notices Nos. 1, 2, 3, 4, 5, 6 as applicable).

Term of Validity: This certificate is valid until 16 SEP 2009. The user of the product is responsible for compliance with the Rules of the American Bureau of Shipping (ABS) and the Rules of the American Bureau of Shipping (ABS) for the Classification of Ships (July 2009) and the Rules of the American Bureau of Shipping (ABS) for the Classification of Mobile Offshore Units (September 1996 plus Notices Nos. 1, 2, 3, 4, 5, 6 as applicable).

ABS Rules: This certificate is valid until 16 SEP 2009. The user of the product is responsible for compliance with the Rules of the American Bureau of Shipping (ABS) and the Rules of the American Bureau of Shipping (ABS) for the Classification of Ships (July 2009) and the Rules of the American Bureau of Shipping (ABS) for the Classification of Mobile Offshore Units (September 1996 plus Notices Nos. 1, 2, 3, 4, 5, 6 as applicable).

National Standards: This certificate is valid until 16 SEP 2009. The user of the product is responsible for compliance with the Rules of the American Bureau of Shipping (ABS) and the Rules of the American Bureau of Shipping (ABS) for the Classification of Ships (July 2009) and the Rules of the American Bureau of Shipping (ABS) for the Classification of Mobile Offshore Units (September 1996 plus Notices Nos. 1, 2, 3, 4, 5, 6 as applicable).

Manufacturer's Declaration: This certificate is valid until 16 SEP 2009. The user of the product is responsible for compliance with the Rules of the American Bureau of Shipping (ABS) and the Rules of the American Bureau of Shipping (ABS) for the Classification of Ships (July 2009) and the Rules of the American Bureau of Shipping (ABS) for the Classification of Mobile Offshore Units (September 1996 plus Notices Nos. 1, 2, 3, 4, 5, 6 as applicable).

Other: This certificate is valid until 16 SEP 2009. The user of the product is responsible for compliance with the Rules of the American Bureau of Shipping (ABS) and the Rules of the American Bureau of Shipping (ABS) for the Classification of Ships (July 2009) and the Rules of the American Bureau of Shipping (ABS) for the Classification of Mobile Offshore Units (September 1996 plus Notices Nos. 1, 2, 3, 4, 5, 6 as applicable).

**ABS**

**CERTIFICATE OF Design Assessment**

This is to Certify that a representative of this Bureau did, at the request of **ALFAGOMMA S.p.A.**

conduct a design assessment of the product(s) shown below. The design assessment was conducted in accordance with the Rules of the American Bureau of Shipping (ABS) and the Rules of the American Bureau of Shipping (ABS) for the Classification of Ships (July 2009) and the Rules of the American Bureau of Shipping (ABS) for the Classification of Mobile Offshore Units (September 1996 plus Notices Nos. 1, 2, 3, 4, 5, 6 as applicable).

The design assessment was conducted by a representative of this Bureau, duly authorized, who has issued a Certificate of Approval (COA) for the product. The COA is a statement of the Bureau's approval of the product and is subject to the terms and conditions of the Rules of the American Bureau of Shipping (ABS) and the Rules of the American Bureau of Shipping (ABS) for the Classification of Ships (July 2009) and the Rules of the American Bureau of Shipping (ABS) for the Classification of Mobile Offshore Units (September 1996 plus Notices Nos. 1, 2, 3, 4, 5, 6 as applicable).

The above certifies the product to be used in accordance with the Rules of the American Bureau of Shipping (ABS) and the Rules of the American Bureau of Shipping (ABS) for the Classification of Ships (July 2009) and the Rules of the American Bureau of Shipping (ABS) for the Classification of Mobile Offshore Units (September 1996 plus Notices Nos. 1, 2, 3, 4, 5, 6 as applicable).

ABS issues no representation regarding Type Approval of the Product for use on vessels, MOU's or facilities unless the use of the ABS Rules is required for the operation.

Due to the complexity of specifications used in the product, ABS has evaluated for Type Approval, it is part of our contract that neither the product is an ABS Rule or ABS Rule, nor does the user have responsibility for compliance with the ABS Rules.

**ALFAGOMMA S.p.A.**

Comments: This certificate is valid until 16 SEP 2009. The user of the product is responsible for compliance with the Rules of the American Bureau of Shipping (ABS) and the Rules of the American Bureau of Shipping (ABS) for the Classification of Ships (July 2009) and the Rules of the American Bureau of Shipping (ABS) for the Classification of Mobile Offshore Units (September 1996 plus Notices Nos. 1, 2, 3, 4, 5, 6 as applicable).

**CERTIFICATE OF REGISTRATION**

REKORSAN OTOMOTIV SAN. TIC. LTD. ŞTİ.

ŞEHAN ÖZEL ORGANİZASYON SAN. VE TİC. A.Ş. (ŞEHAN OTOMOTİV SAN. VE TİC. A.Ş.)

Sertifika No: 4972/2008

ISO 9001:2008

HİDROLIK REKOR İMALATI

KAPSAN KİMYA İMALATI SAN. VE TİC. A.Ş.

KA KODU: KA 17

Not: Bu belge, ISO 9001:2008 uluslararası standartlarına göre değerlendirilmiştir. (This certificate is based on the results of the audit conducted in accordance with the ISO 9001:2008 standard.)

Sertifika Geçerlilik Tarihi: 13 Oca 2012  
Sertifika Güncelleme Tarihi: 13 Oca 2013  
Sertifika Bitiş Tarihi: 13 Oca 2015

Geçerli Müdür  
Lid Nurettin YILMAZ

DCA